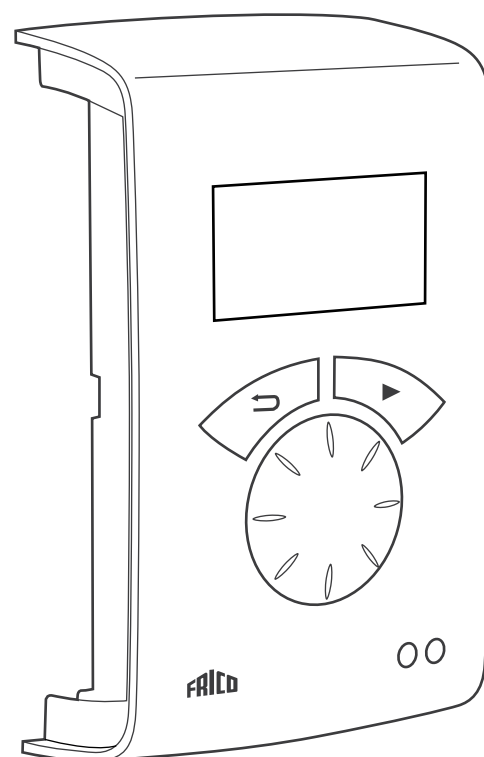

Original instructions

**SIRe Advanced
Fan Heater - Water
With quick guide****SIReFA
SIReFAWM**

SE ... 2

GB ... 22

DE ... 42

FR ... 62

ES ... 82

IT ... 103

NL ... 123

NO ... 144

PL ... 164

RU ... 184

For wiring diagram, please see last pages.

Quick guide/start up

Check that all constituent parts are present (see section Constituent parts).

Advice about location

PC board HUB SIReA1X is installed close to the unit.

Control unit SIReUA1 has an integrated room temperature sensor and is installed so that it is easily accessible to the user. RJ12 (6p/6c) modular cables, which are available in different lengths, are used to connect the PC board and the control unit. Longer cables are available as options. Maximum cable lengths see section Options.

To prevent unauthorised people from accessing the Control unit it can instead be placed in another area and an external room sensor, SIReRTX (option), can be installed in the premises to sense the correct temperature.

Connect the system

In control board base SIReB1(X) the unit is connected further with RJ12 (6p/6c) modular cable if several units are to be connected in parallel.

If an external room temperature sensor SIReRTX (option) is used it is connected using modular cable RJ11 (4p/4c) on HUB SIReA1X.

The actuator for water control and outdoor sensor SIReOTX is connected on PC Board HUB SIReA1X.

Transformer for voltage supply of the valve actuator is connected with quick terminal block on PC Board Base SIReB1(X) (230V) and 24V and onward to the actuator.

If return water temp. sensor SIReWTA is used, it is connected with modular cable RJ11 (4p/4c) on PC Board Base SIReB1(X).

Control board Base SIReB1(X) in/at the unit and control unit SIReUA1 are connected by PC board HUB SIReA1X with RJ12 (6p/6c) modular cables, after the other units are powered up.

For fixed installation requirements, remove the supplied cable and plug. Perform the installation in accordance with applicable regulations.

Wiring diagrams

The wiring diagrams are in a separate section at the end of this manual.

When external PC board Base SIReB1X is used, wiring between the PC board base and the unit must be done. Please see separate manual for SIReB1X.

Enter ID/Operation without control unit

The control system can control one or more units in parallel (max 9). Each unit must get a unique ID number (1-9) which is set in the ID selector of the PC board. E.g. Unit 1: ID=1, unit 2: ID=3

If the external control for some reason has not been installed the unit can still be run temporarily. The ID selector is then set to mode 0 see the image below.

The function is half speed and heating is on.

When the ID number must be changed the unit must be disconnected from power.

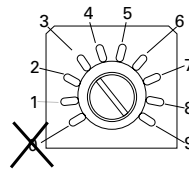

Each unit should have a unique ID on its SIReB1X card.

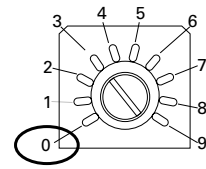

To run the unit temporarily without external control select mode 0.

Start up

System supplied with power. At the first start up, the start-up wizard is run and the basic settings are made. Fan and heating steps are tested through the test program. Then a status window is displayed.

At the first start up alarm and error codes can occur, these will usually be reset without actions.

Unit with mixing cabinet

When a mixing cabinet is used the supplied Return temp. sensor SIReWTA must be installed. SIReWTA is a clamp-on sensor which is installed on the return water pipe as close to the coil as possible. The sensor must be insulated so it is not influenced by the ambient temperature.

In order for the Return temp. Sensor to detect the correct temperature in the return circuit when the valve actuator is closed, a circulation pump must be installed in the secondary circuit.

Damper motor PSM01 must be installed on the throttle spindle to the mixing cabinet. Electrical connection between the damper motor and PC board HUB SIReA1X and transformer ST23024 (see the wiring diagram at the end of the manual).

Start-up wizard

- | | |
|---|---|
| <p>1 Start-up wizard
Set language
English</p> | <p>Screen function test
Start-up wizard
Fan step 1-5
Heating step off-1</p> |
| <p>2 Start-up wizard
Set temp. unit
°C</p> | <p>6 Start-up wizard
Function test
Test completed
Restart test</p> |
| <p>3 Start-up wizard
Set date
2011-05-28
YYYY-MM-DD</p> | <p>7 Start-up wizard
Eco / Comfort
Comfort mode
Eco mode</p> |
| <p>4 Start-up wizard
Set time
14:07
24h format</p> | <p>8 Start-up wizard
External filter guard
OFF
ON</p> |
| <p>Checking system...</p> | <p>9 Start-up wizard
Mixing cabinet on/off
OFF
ON</p> |
| <p>5 Start-up wizard
Function test
Start test
Skip test</p> | <p>10 Start-up wizard
Start-up finished
Proceed
Restart wizard</p> |

Start up

Select mixing cabinet On in the start-up wizard.

SDM24

For actuator SDM24 (included in the valve kit) to work with SIRe the setting should be as follows:

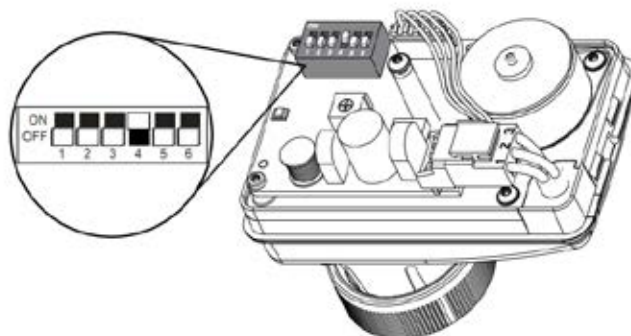

Contents

Quick guide/start up

Advice about location	22
Connect the system	22
Wiring diagrams	22
Enter ID/Operation without control unit	22
Start up	23
Unit with mixing cabinet	23
Start up	23
Jumper settings	23

Constituent parts

SIReFA (without mixing cabinet)	25
SIREFAWM (with mixing cabinet)	26

Operating modes

Operating modes (without mixing cabinet)	29
Operating modes (with mixing cabinet)	29

Control unit SIReUA1

Overview	30
Statuswindow	30

Main menu

Current settings	31
Temperature settings	31
Fan control	31
System on/off	31
Installer menu	31

Installer menu

Installer status screen	32
Week program	32
Fan settings	33
Heating settings	33
Filter guard settings	35
External filter guard	35
Mixing cabinet	35
External control (BMS)	36
General settings	37
Service menu	37

Alarm and error codes

Displaying alarm and error codes	38
Reset alarm	38
Overheat protection	38
Power failure	38
Frost protection function	38

Wiring diagrams, see last pages

Constituent parts

SIReFA (without mixing cabinet)

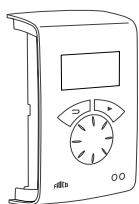

SIReUA1,
control unit
Competent and
Advanced

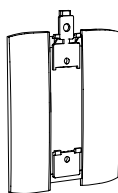

Wall unit cover

Integrated in fan heater

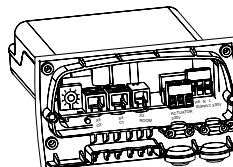

SIReB1/B2,
integrated PC
Board Base

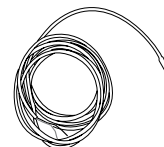

SIReIT, internal
temperature
sensor

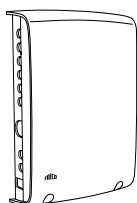

SIReA1X,
PC board HUB Advanced



SIReOTX,
outdoor temperature
sensor

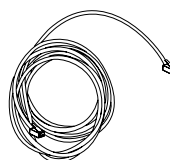

SIReCC,
modular cable

Dimensions constituent parts

Type	Description	HxWxD [mm]	L [m]
SIReUA1	Control unit Competent and Advanced	120x70x35	
SIReB1	Integrated PC board Base		
SIReIT	Internal temperature sensor		1
SIReA1X	PC Board HUB Advanced	202x139x50	
SIReOTX	Outdoor temperature sensor	70x33x23	
SIReCC603	Modular cable RJ12 (6/6)		3
SIReCC605	Modular cable RJ12 (6/6)		5

SIREFAWM (with mixing cabinet)

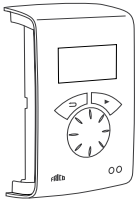

SIReUA1,
control unit
Competent and
Advanced

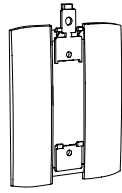

Wall unit cover

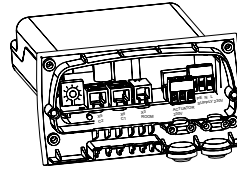

SIReB1/B2,
integrated PC
Board Base



SIReIT, internal
temperature
sensor

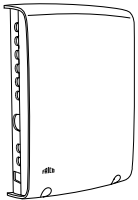

SIReA1X,
PC board HUB
Advanced



SIReOTX,
outdoor
temperature
sensor

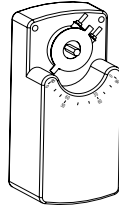

SMM24,
damper motor

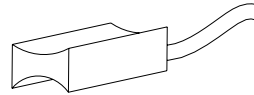

SIReWTA,
clamp-on sensor

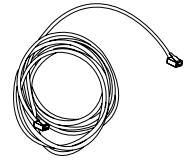

SIReCC,
modular cable

Dimensions constituent parts

Type	Description	HxWxD [mm]	L [m]
SIReUA1	Control unit Competent and Advanced	120x70x35	
SIReB1	Integrated PC board Base		
SIReIT	Internal temperature sensor		1
SIReA1X	PC Board HUB Advanced	202x139x50	
SIReOTX	Outdoor temperature sensor	70x33x23	
SMM24	Damper motor 24V	241x116x88	
SIReWTA	Clamp-on sensor RJ11 (4/4)		3
SIReCC603	Modular cable RJ12(6/6)		3
SIReCC605	Modular cable RJ12 (6/6)		5

Option

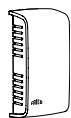

SIReRTX, external room temperature sensor

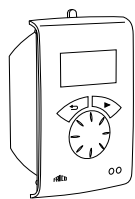

SIReUR, kit for recessed installation



SIReCJ4, joint piece



SIReCJ6, joint piece

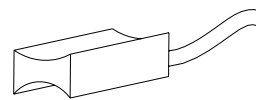

SIReWTA, clamp-on sensor

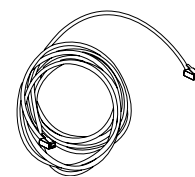

SIReCC, modular cable

Type	RSK-no.	E-no.	Description	HxWxD	L [m]
SIReRTX	673 09 22	87 510 12	External room temperature sensor	70x33x23	
SIReUR*	673 09 21	87 510 11	Kit for recessed installation	114x70x50	
SIReCJ4			Joint piece for two pcs. RJ11 (4/4)		
SIReCJ6			Joint piece for two pcs. RJ12 (6/6)		
SIReWTA			Clamp-on sensor RJ11 (4/4)		
SIReCC603	673 09 23	87 510 13	Modular cable RJ12 (6/6)		3
SIReCC605	673 09 24	87 510 14	Modular cable RJ12 (6/6)		5
SIReCC610	673 09 25	87 510 15	Modular cable RJ12 (6/6)		10
SIReCC615	673 09 26	87 510 16	Modular cable RJ12 (6/6)		15
SIReCC403	673 09 27	87 510 17	Modular cable RJ11 (4/4)		3
SIReCC405	673 09 28	87 510 18	Modular cable RJ11 (4/4)		5
SIReCC410	673 09 29	87 510 19	Modular cable RJ11 (4/4)		10
SIReCC415	673 09 30	87 510 20	Modular cable RJ11 (4/4)		15

*) See separate manual.

Max. cable lengths

Modular cable RJ12 (6p/6c) between SIReUA1 and SIReA1X: max. 50 m.

Modular cable RJ12 (6p/6c) between SIReA1X and SIReB1(X): max. 10 m.

Modular cable RJ12 (6p/6c) between two SIReB1(X): max. 50 m.

Modular cable RJ11 (4p/4c) to room sensor SIReRTX: max. 20 m.

Cable for outdoor sensor SIReOTX (not modular): max. 50 m.

Total cable length permitted in the system is a maximum of 300 m.

Water control - valve kit

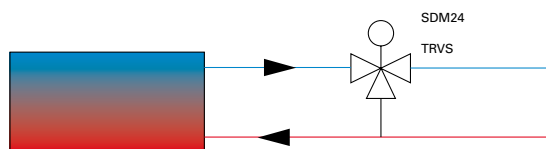
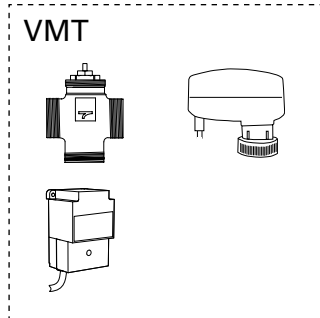
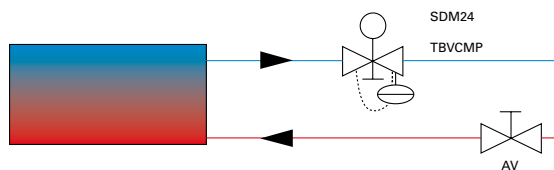
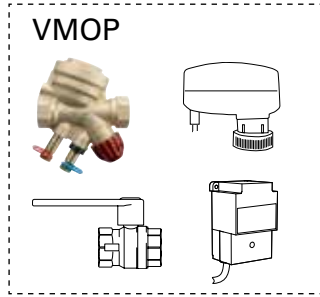
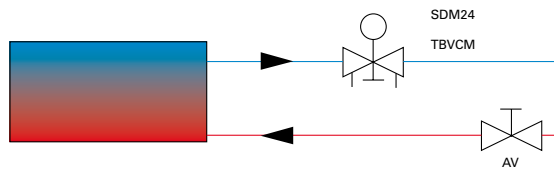
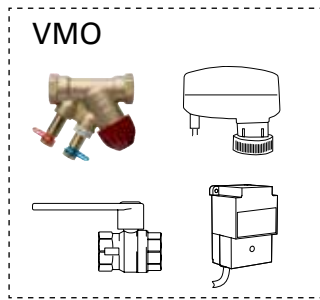

Water control - option



VAT, adjustment tool for valve package.

Type	RSK-no.	Description	Connection
VMO15LF	673 09 47	Modulating	DN15
VMO15NF	673 09 48	Modulating	DN15
VMO20	673 09 49	Modulating	DN20
VMO25	673 09 50	Modulating	DN25
VMOP15LF	673 09 51	Pressure independent and modulating	DN15
VMOP15NF	673 09 52	Pressure independent and modulating	DN15
VMOP20	673 09 53	Pressure independent and modulating	DN20
VMOP25	673 09 54	Pressure independent and modulating	DN25
VMT15		Three way valve and modulating actuator	DN15
VMT20		Three way valve and modulating actuator	DN20
VMT25		Three way valve and modulating actuator	DN25
VAT		Adjustment tool for valve package	

Operating modes

Operating modes (without mixing cabinet)

Control is based on the four operating modes:

- Auto
- Thermostat / Manual fan
- Thermostat / Automatic fan
- Manual

Auto

When the set point value is undercut by 0.5 K the fan starts at speed 1 and the valve motor starts to open stepless. If a fully open valve is not sufficient to maintain the temperature, the fan control increases to a max of step 4. The difference between the setpoint value and the room temperature for the fan to increase one step is set under Heating step diff., see Installer menu > Settings heating > Heating step diff.

When Auto is active the fan speed and heating cannot be changed in the status window.

Thermostat / Manual fan

The thermostat just controls the heating and the fan runs continually. The fan speed is set manually. The fan symbol is marked in the status window, select desired speed with the rotary dial and confirm.

Thermostat / Automatic fan

The thermostat controls both the heating and the fan. The fan speed is set manually in the status window.

[Installer menu > Settings fan > Fan mode.]

Manual

The fan speed and heating is set manually in the status window. Heating can be set to 3 steps (33%, 66% and 100%). Heating is blocked by the outdoor temperature, see: [Installer menu > Settings heating > Outdoor temp. limit]

Operating modes (with mixing cabinet)

The control is based on two operating modes:

Thermostat / Manual fan

Manual

Thermostat / Manual fan

The thermostat just controls the heating and the fan runs continually. The fan speed is set manually. The fan symbol is marked in the status window, select desired speed with the rotary dial and confirm.

Day mode

In day mode or if no week program is activated, the fan runs continuously at the fixed fan control and the damper is open according to the setting under Day damper pos.. The heating is controlled via the room temperature. If the inflow temperature drops below the set minimum value, heat connects even if it is sufficiently warm in the premises.

Night mode

Night time (when the week program is activated or via external signal for night reduction) the damper is fully closed or open according to the setting under Night damper pos. Heating is controlled by the room temperature and the fan is running continuously.

Manual

The fan speed and heating is set manually in the status window. Heating can be set to 3 steps (33%, 66% and 100%). Heating is blocked by the outdoor temperature, see: [Installer menu > Settings heating > Outdoor temp. limit]

When the mixing cabinet is activated the Return temp. sensor SIReWTA is also activated. If this sensor is not installed an alarm is indicated. The return temperature sensor must be installed to reset the alarm [Settings heating> Return water temp.

Control unit SIReUA1

Overview

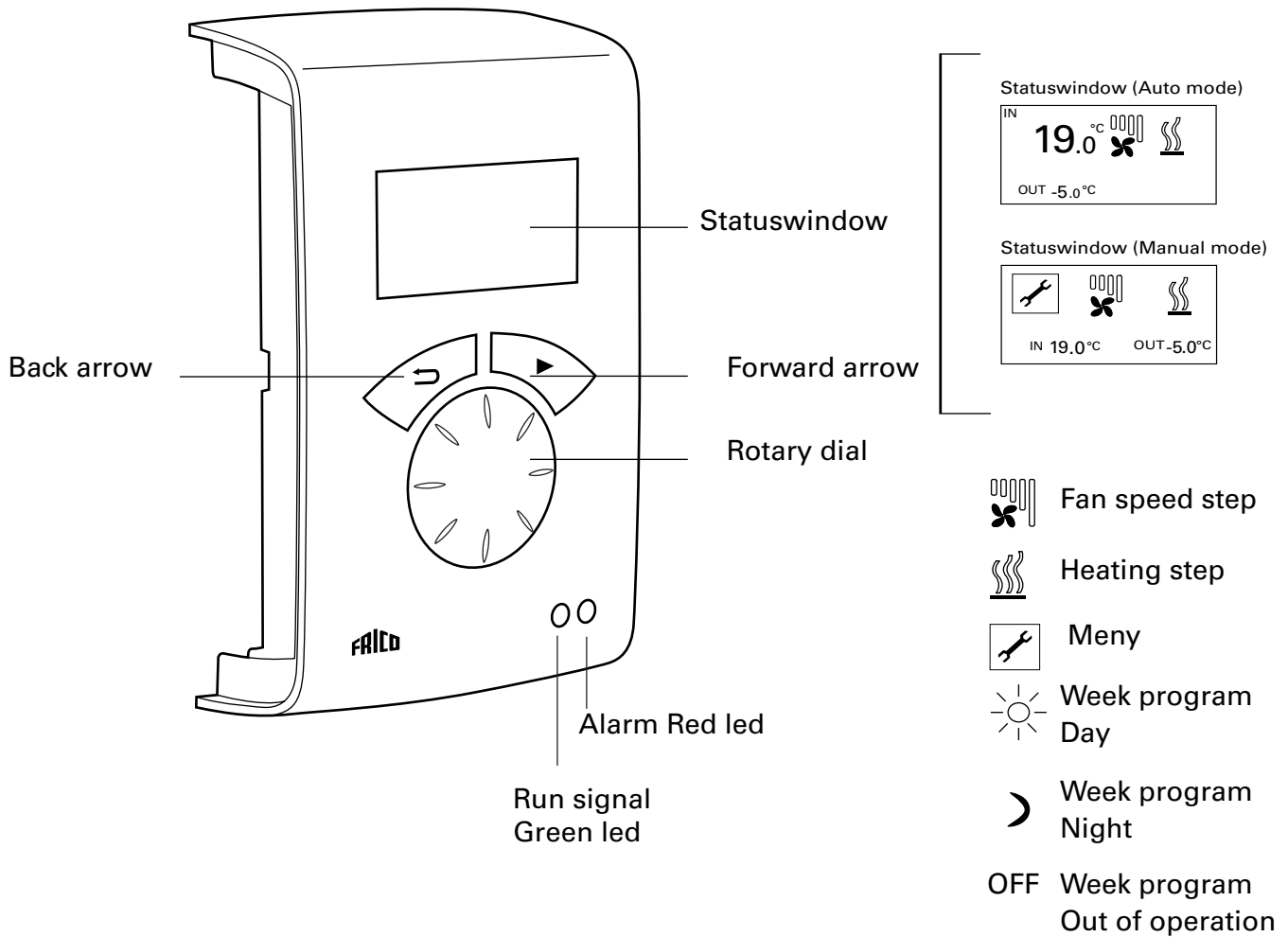

Explanations

Statuswindow

The display shows prevailing room temperature, outdoor temperature, fan and heating step and day, night mode, or Off when week program is used.

This also displays whether the control is set to auto mode or manual mode.

Forward arrow

Confirm selection and proceed.

Rotary dial

Scroll between alternatives

Back arrow

Go back.

After three minutes the control unit goes back to displaying the status window.

Statuswindow

For thermostat/manual control of the fan and heating the relevant symbol is marked in the status window with the forward arrow. Steps can then be set, confirm with the forward arrow. For description, see section Operating modes.

Press the forward arrow to access the main menu.

Main menu

Current settings

Displays set room temp, high speed limit and week program status.

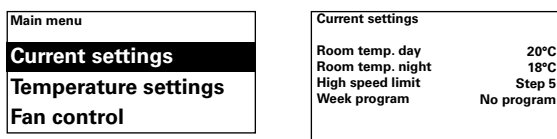

Temperature settings

Set the desired room temperatures to apply for day respectively night mode (room temperature night is used for week program/night reduction).

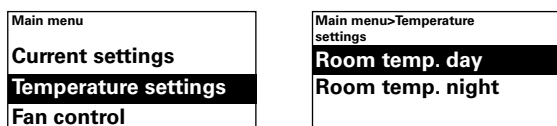

Factory setting

Room temp. day: 20°C (5 – 35°C)

Room temp. night: 18°C (0 – 20°C)

Fan control

Possibility of limiting high speed mode. In Auto mode (see fan settings) the fan high speed limit is set automatically to step 4 in order to keep the sound level down. If you wish to further restrict the fan control it can be done here.

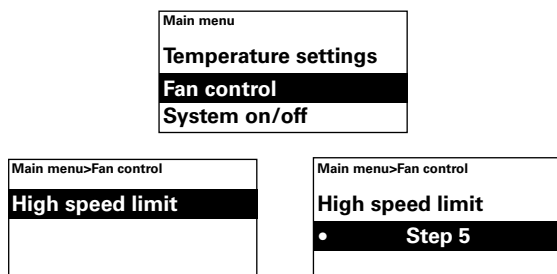

Factory setting

High speed limit: 5 (1-5)

System on/off

Switch the whole unit off manually. In Off the display goes out; as soon as a button is pushed the display lights and shows System on/off. To activate the unit again select On.

The unit's safety functions are still active when the system is switched off, which means that the fan can continue to run for a moment after mode Off has been selected.

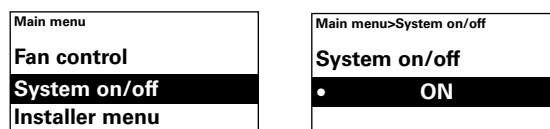

Installer menu

The installer menu is at the bottom of the main menu, this is password protected. See Installer menu in this manual.

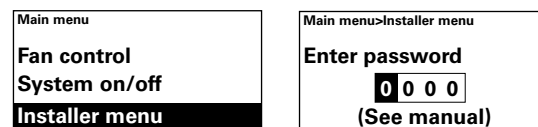

Installer menu

To enter the Installer menu, code 1932 is entered. Select the digits using the rotary dial and confirm using the forward arrow.



Installer status screen

Check the settings. The installer status screen consists of three pages with settings, scroll using the rotary dial.

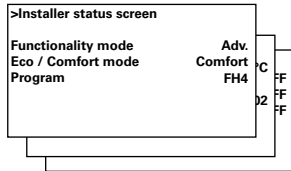
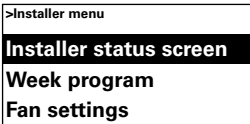

Week program

Make settings for week program.

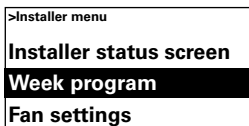

A basic program is pre-entered in SIRe.
 Mon-Fri Day from 08:00, Night from 18:00
 Sat Day from 10:00, Night from 16:00
 Sun Day from 11:00:00, Night from 14:00

To check which program is set for a particular day, select Check program and then switch between the days using the rotary dial.

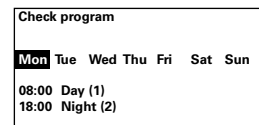

To check which days a certain program is active, select a week day by pressing the forward arrow, the program is marked and those days that the program is used will be underlined, switch between the programs for a particular day using the rotary wheel.

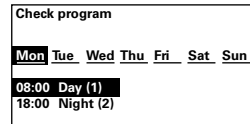

To add program step, select New program step. Confirm your selection with the forward arrow. Select Day, Night or Off (if the unit should not be in operation), set the time for switch on and then for which days the program applies, then go to End to finish.

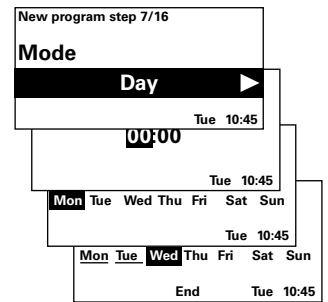
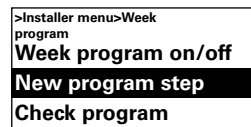

A new program step does not replace a set time for Day for example, but you can instead select to change a program step.

To change a program step, select Change program.

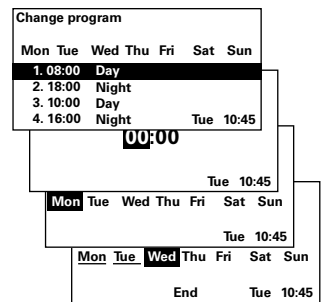

The program steps that should not apply are removed in Remove program. One or all program steps can be removed in the menu. To return to the factory set basic program, select Reset all.

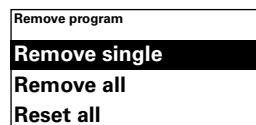

Week program is activated by selecting On, under Week program on/off. In On-mode, a sun, moon or Off in the Status window appears to indicate day, night respectively Off-function.



Fan settings

Make settings for fan mode (see also Operating modes section).

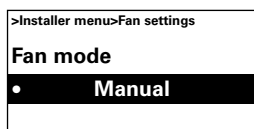
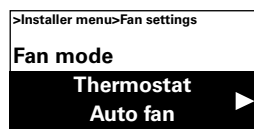
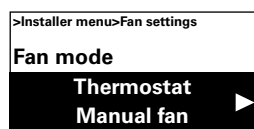
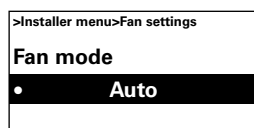
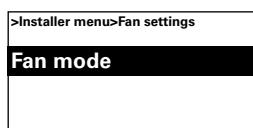
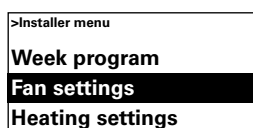

Factory setting

Fan mode: Auto (Thermostat / Manual fan, Thermostat / Automatic fan, Manual)

Stepless fan control

Settings for stepless fan control. Fan control can be controlled in 5 steps or steplessly through external steering from BMS (0-10V). During stepless control, 0-10V output (terminal block 1-2 on SIReA1X) is used, connected to external speed control (not included). Stepless control is not possible when a mixing cabinet is used.

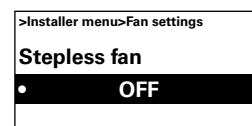
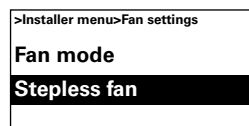

Factory setting

Stepless fan control: Off (On)

Heating settings

Make settings for heating.

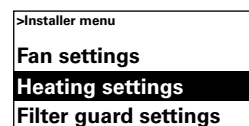

Outdoor temp. limit

Blocking heating summer time.

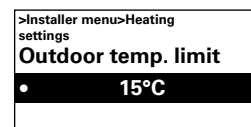

Factory setting

Outdoor temp. limit: 15°C (5 – 30°C)

Eco / Comfort (without mixing cabinet)

Select Comfort to prioritise temperature and ventilation comfort.

Select Eco to prioritise low energy consumption by maximize the outlet temperature to +32°C

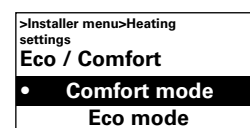
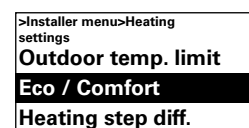

Control with mixing cabinet, with falling outlet temp

Comfort:

1. Opens the valve gradually to fully open valve.
2. Gradually closes damper to night mode
3. Slows down the fan.

Eco:

1. Gradually closes damper to night mode
2. Opens the valve gradually to full heating.
3. Slows down the fan.

Max. outlet temp. limit +32°C.

Heating step diff.

When the temperature falls below the set point value the fan speed increases (the high speed limit is position 4). Which temperature difference the speed is to be increased by a step for is selected in Heating step diff.

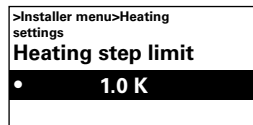
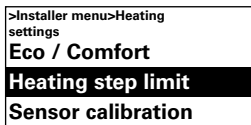

Factory setting

Heating step diff.: 1.0 K (-10 K – 10 K)

Sensor calibration

If the sensor displays the wrong values these can be calibrated. Some display errors may occur, but this is primarily due to the location (cold/hot surfaces etc). The value + or – adds to or subtracts from the measured value (for example +2K gives an increase of the displayed value of 2 degrees).

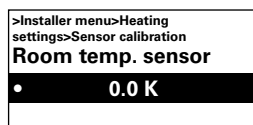
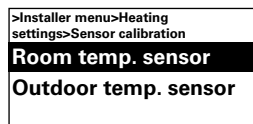
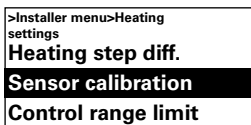

Factory setting

Room temperature sensor: 0.0 K (-10 K – 10 K)

Return water temp.

If there is a demand for the temperature of the return water not to exceed a certain value, this function is activated under Return water temp. A return water temperature sensor (proximity sensor SiReWTA, option) must then be installed on the return water pipe.

Install Return temp. Sensor to Connected and select max return temperature (15-90 °C) using the turn wheel. During operation, this function limits the valve's degree of opening, which reduces the flow and the return temperature.

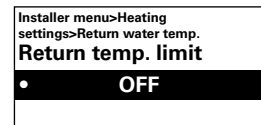
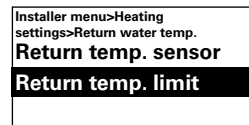
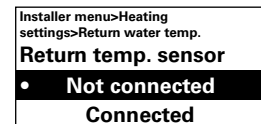
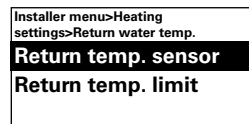
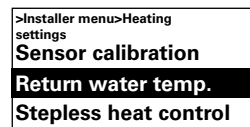

Factory setting

Return temp. sensor: Not connected (Connected)
Return temp. limit: Off (15 – 90°C)

Stepless heat control

To use Advanced fully, stepless heat control must be used.

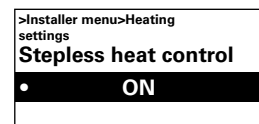
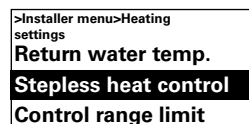

Factory setting

Stepless heat control: ON (Off - not selectable)

Control range limit

The maximum room temperature that a user can select is limited to between 5 – 35°C.

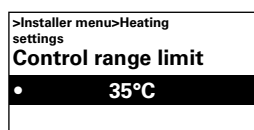
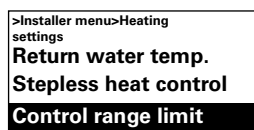

Factory setting

Control range limit temperature: 35°C (5 – 35°C)

Filter guard settings

Filter alarm alarms when the set fixed run time has been exceeded.

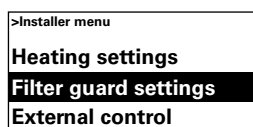

Filter timer setting

Under Filter timer setting, set the desired run time to between 50 and 9950 hours.

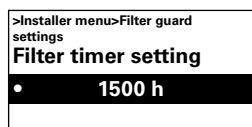

Factory setting

Filter timer setting: 1500 h (50 - 9950 h)

Filter timer on/off

Filter alarm is activated by selecting On, under Filter timer on/off.



Factory setting

Filter timer on/off: Off (On)

External filter guard

If an external filter guard, e.g. a pressure switch, is used, it is activated under External filter guard, select On.



Factory setting

External filter guard: Off (On)

Last filter change

To check the number of run time hours since the last filter replacement, select Last filter change. The time is reset when the filter alarm is reset. If the time is to be reset before the alarm has gone, switch the filter timer on and off.

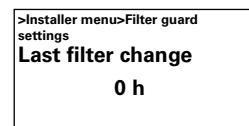

Mixing cabinet

When the mixing part is used, it is activated under Mixing cabinet settings.

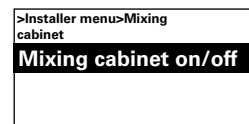
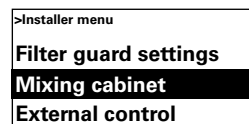

Factory setting

Mixing cabinet on/off: Off (On)

When the mixing cabinet is activated, more options are available in the menu under Mixing cabinet settings.

Min outlet temp.

The outlet temperature must be limited under Min. outlet temp.

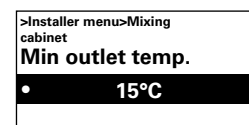
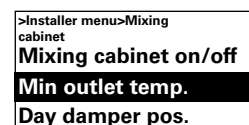

Factory setting

Min outlet temp.: 15°C (5 – 30°C)

Day damper pos.

Desired current damper position daytime.

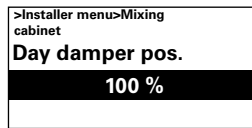

Factory setting

Day damper pos.: 100% (0 – 100%)

Night damper pos.

Desired current damper position nighttime.

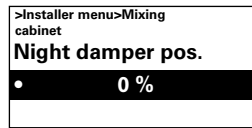

Factory setting

Night damper pos.: 0% (0 – 100%)

External control (BMS)

BMS functions can be activated under External control.

Activate External on/off (5-30V AC/DC from BMS) or 0-10V fan control by selecting On under the respective one. See diagram on next page and Connecting external control.

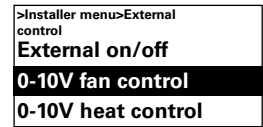
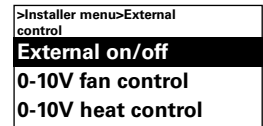
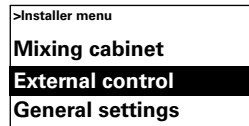

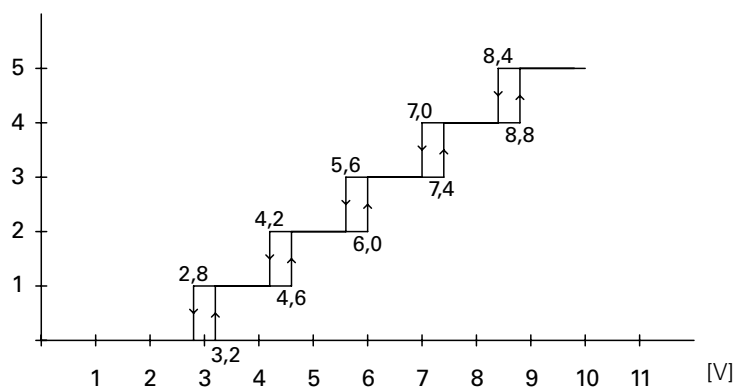

Diagram: Fan step at incoming 0-10V DC voltage level, 5 step

General settings

Possibility of making general settings that are also in the Start-up wizard and execute user reset.



Change the date, time, language and temperature unit.

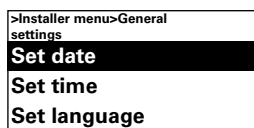

User reset

User reset (Room temp. day resp. night, high speed limit) to factory setting.

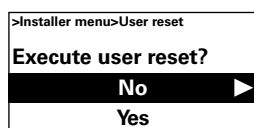
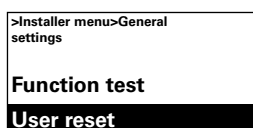

Function test

To test the fan and heating steps, run the function test.

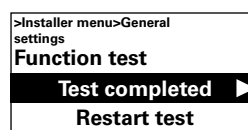
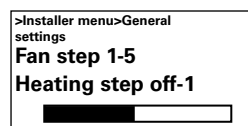
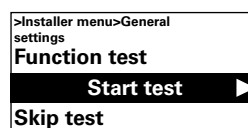

Service menu

The service menu is password protected and is used for support in contact with Frico or authorised installer.

Alarm and error codes

SIRe has different alarms and error codes for safe and problem free operation.

If alarms or error codes have been indicated these must be reset in order to return to normal operation, for example activating the heating again. Fan mode is active even when, for example, the over heating alarm has been indicated.

Displaying alarm and error codes

In event of alarm or error the alarm/error code is shown in the status window. In event of alarm/error code the unit it applies to is displayed.

See Table - Alarms and Table – Error codes.

Reset alarm

Note! Before resetting, check that the fault is rectified and there is nothing to prevent the unit from being recommissioned!

When the fault is rectified, the alarm is reset by pressing the forward arrow and selecting Reset alarm and then confirm. If several units give an alarm at the same time, the fact that there are several alarms is indicated, but only one is shown in the display. By resetting that alarm the next alarm can be read.

At the first start up alarm and error codes can occur, these can usually be reset without action.

Overheat protection

The overheat protection is designed to limit the temperature of the heater to a maximum of +90° C. If the temperature should exceed 95°C e.g. in the event of a faulty valve or actuator, the fan starts to speed up to keep the temperature down.

At the same time there is an overheating alarm A2. At internal temperatures of +100°C the fan runs at maximum speed.

If the unit cools, heating is automatically reengaged. The alarm remains in the control unit's display. If the unit overheats twice within an hour, the fan operates until the alarm is reset.

Power failure

Note that in case of power failure the time settings need to be checked, if the time is not set correctly week program will be affected.

Frost protection function

The frost protection function is intended to prevent the water coil from freezing.

When the fan is in operation the valve actuator opens the valve at an internal temperature below +15°C regardless of whether there is a heating requirement. If the internal unit temperature continues to drop, e.g. at low ambient temperatures, insufficient flow line temperatures, low flow or fault valve function, the frost protection alarm A3 will be triggered when the internal unit temperature drops +5°C. The fan then also stops and when the mixing cabinet is used the dampers is also closed.

With return temp. sensor SIReWTA connected an advanced alarm function occurs. At return temperatures less than +15°C the actuator will open regardless of the heat demand. Alarm is triggered at return temperature +7°C and the fan also stops.

When the fan is not running there is a heat retention function that opens the valve when the water's return temperature falls below +25°C regardless of heat demand.

Note! In event of repeated alarms, overheating alarms and frost protection alarms, carry out a thorough check and if the fault cause cannot be found contact authorised installer or Frico.

Table - Alarm

Alarm		Cause	Action
A1	Motor alarm	Thermal switch has deployed. One or several motors have overheated. (Only units with withdrawn thermal switches.)	Check that nothing is obstructing the unit's air intake and exhaust. When the overheated motor has cooled the thermal switch shuts again and the alarm can be reset. At repeated alarms, check the motors, replace damaged motors.
A2	Over heating alarm	The temperature in the unit has exceeded the alarm limit for overheating.	Check that nothing is obstructing the unit's air intake and exhaust, the function of the actuator and valve, flow temperature and internal temperature sensor.
A3	Frost protection alarm	The temperature in the unit has fallen below the alarm limit for frost protection. (Only applies to units with internal unit temperature.)	Make sure that the ambient temperature where the unit is installed exceeds +5°C. Check the flow temperature, the flow of hot water and the function of the actuator and valve. In event of an alarm there a risk that the battery is damaged, check carefully for leakage and replace the battery if damaged.
A4	Filter alarm	Fixed run time before the filter alarm has been reached. or the external filter alarm has been activated.	Replace or clean the filter, adjust any alarm time based on how dirty the filter was and reset the alarm.
A5	Ext. alarm	External alarm input on SIReA1X has been activated.	Check the external alarm.

Table - Error codes

Error code		Cause	Action
E1	Communication	SIReB1(X) has no contact with SIReA1X.	Check connection between the boards. Replace any modular cables.
E2	ID Error	Two or more SIReB1(X) have the same ID-number.	Interrupt the current and select different ID numbers for all SIReB1(X) in the system.
E3	ID Error	One or more SIReB1(X) do not have programs.	Contact Frico for support.
E4	Room sensor error	Fault on or missing external room sensor SIReRTX connected to SIReB1(X).	Always disconnect the power when connecting or disconnecting sensors. Check connection of the sensor.
E6	Sensor alarm Return water temp.	Fault on or missing return water temp. sensor SIReWTA connected to SIReB1(X).	Always disconnect the power when connecting or disconnecting sensors. Check connection of the sensor. If the sensor is not used, it must not be activated (see the Settings heating section)
E8	Internal sensor faults	Fault on or missing internal sensor in the unit.	Check connection of the sensor. If there is no sensor, contact Frico for support.
E10	ID Error	Two or more SIReB1(X) in the system have different programs.	Contact Frico for support.
E12	Room sensor error	Fault on or missing external room sensor SIReRTX connected to SIReA1X.	Always disconnect the power when connecting or disconnecting sensors. Check connection of the sensor.
E14	Outdoor sensor fault	Fault on or missing outdoor temperature sensor SIReOTX connected to SIReA1X.	Always disconnect the power when connecting or disconnecting sensors. Check connection of the sensor.
E20	Communication	Control unit SIReUA1 has no contact with SIReA1X.	Check the connection. Replace any modular cables.
E21	Room sensor error	Error in the internal room sensor in the control unit SIReUA1.	Check connection between SIReUA1 and SIReA1X. Replace any modular cables. If the error is not rectified SIReUA1 must be replaced.
E23	Soft ware error	Contact Frico for support.	

Connecting external control - including BMS functions

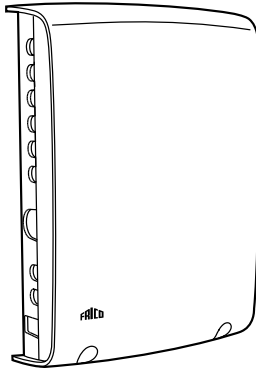

- RPM indication
- Heating indication
- Outdoor temp. sensor
- External night reduction
- External alarm IN
- Ext. speed ctrl. 0-10V DC IN
- Ext. Heating control 0-10V DC IN
- External ON/OFF
- ALARM OUT (BMS)

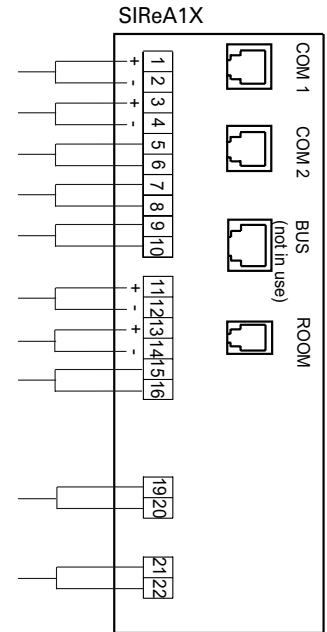

RPM indication
 0-10V DC OUT (max 5 mA)
 Signal from SIRe indicates fan control, corresponds to 0-100% fan control. Always active.

Operation indication OUT (BMS)

Heating indication
 0-10V DC OUT (max 5 mA)
 Signal from SIRe indicates connected heating step. Always active. Control signal to modulating actuator.

Ext. Heating control 0-10V DC IN
 Activates heating. Set parameter: >> Installer menu > External control > 0-10V heating control. = On

Outdoor temp. sensor (obligatory)
 SIReOTX

External on/off 5-30V AC/DC
 External signal activates the unit. Set parameter: >> Installer menu > External control > External On/Off = On

External night reduction on/off (potential-free switch)
 Closes to activate the night reduction function. Always active.

Alarm outgoing (BMS) (potential-free switch, max 3A, 230V)
 Outgoing alarm indication. Always active.
 Closed = buzzer alarm
 Open = no alarm

External alarm IN (potential free contact)
 An external filter guard closes to indicate an alarm. Set Parameter: >> Installer menu > Filter guard > External filter guard = On

External rpm control 0-10V DC
 Control fan control 0-100%.
 Set parameter: >> Installer menu > External control > 0-10V Fan control = On

Operation indication OUT (BMS) (potential free contact) max 3A, 230V
 Outgoing operation indication. Always active.

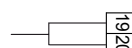
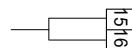
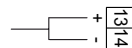
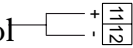
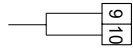
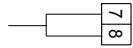
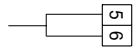
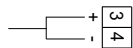
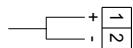

Wiring diagram - Advanced – without mixing cabinet

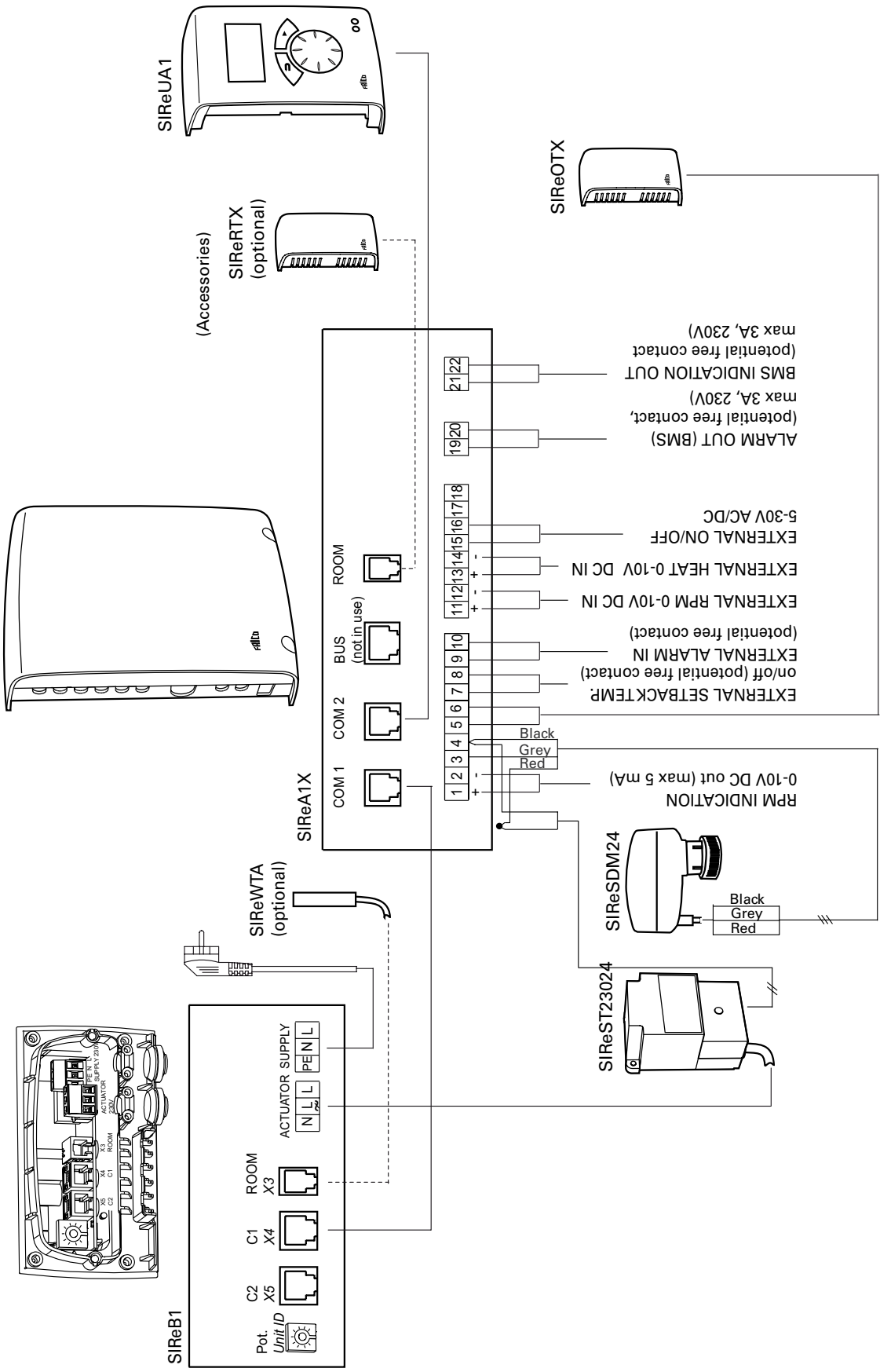

Wiring diagram - Advanced – with mixing cabinet

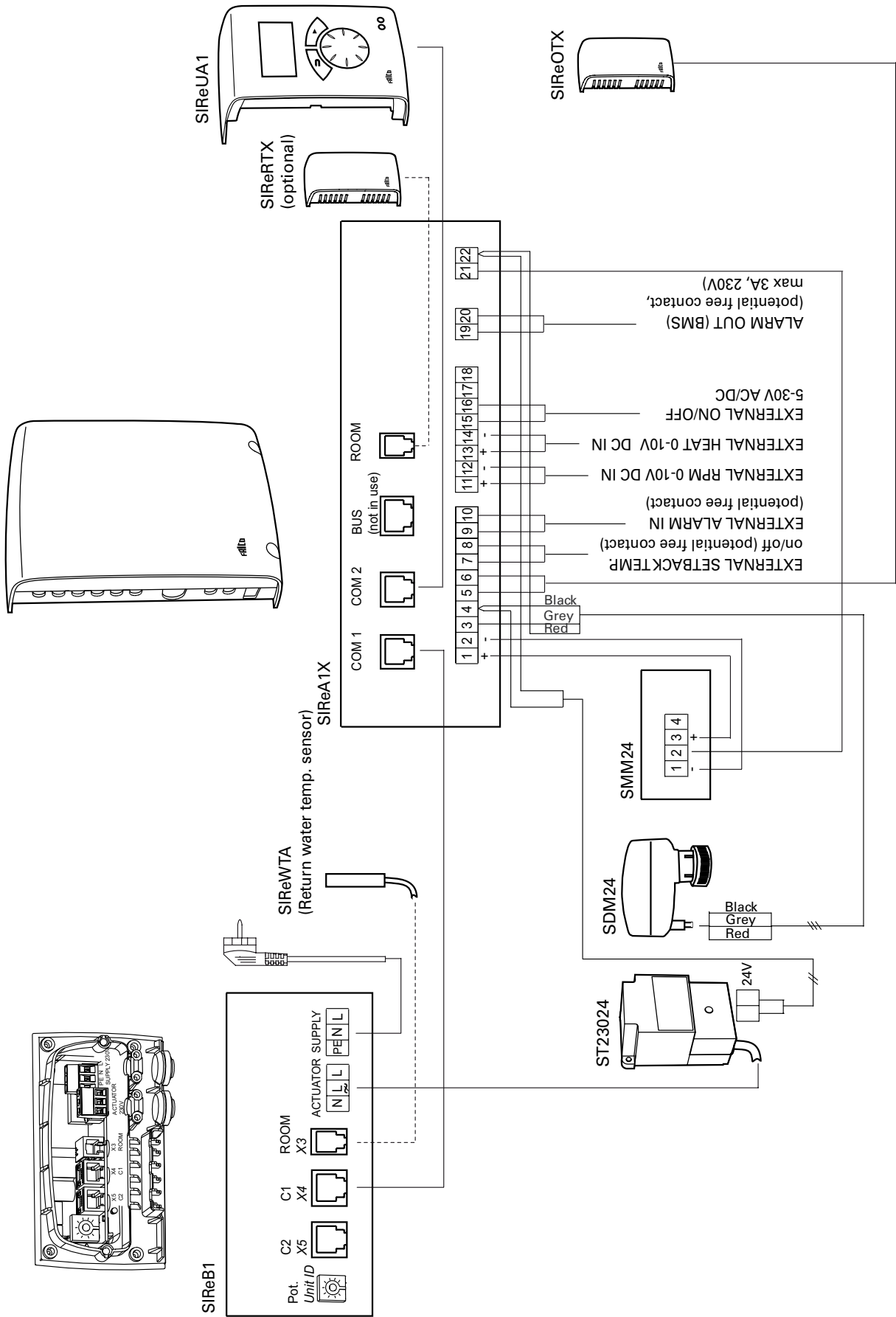

Wiring diagram - Advanced – parallel connection

SIRe Advanced Fan Heater Water

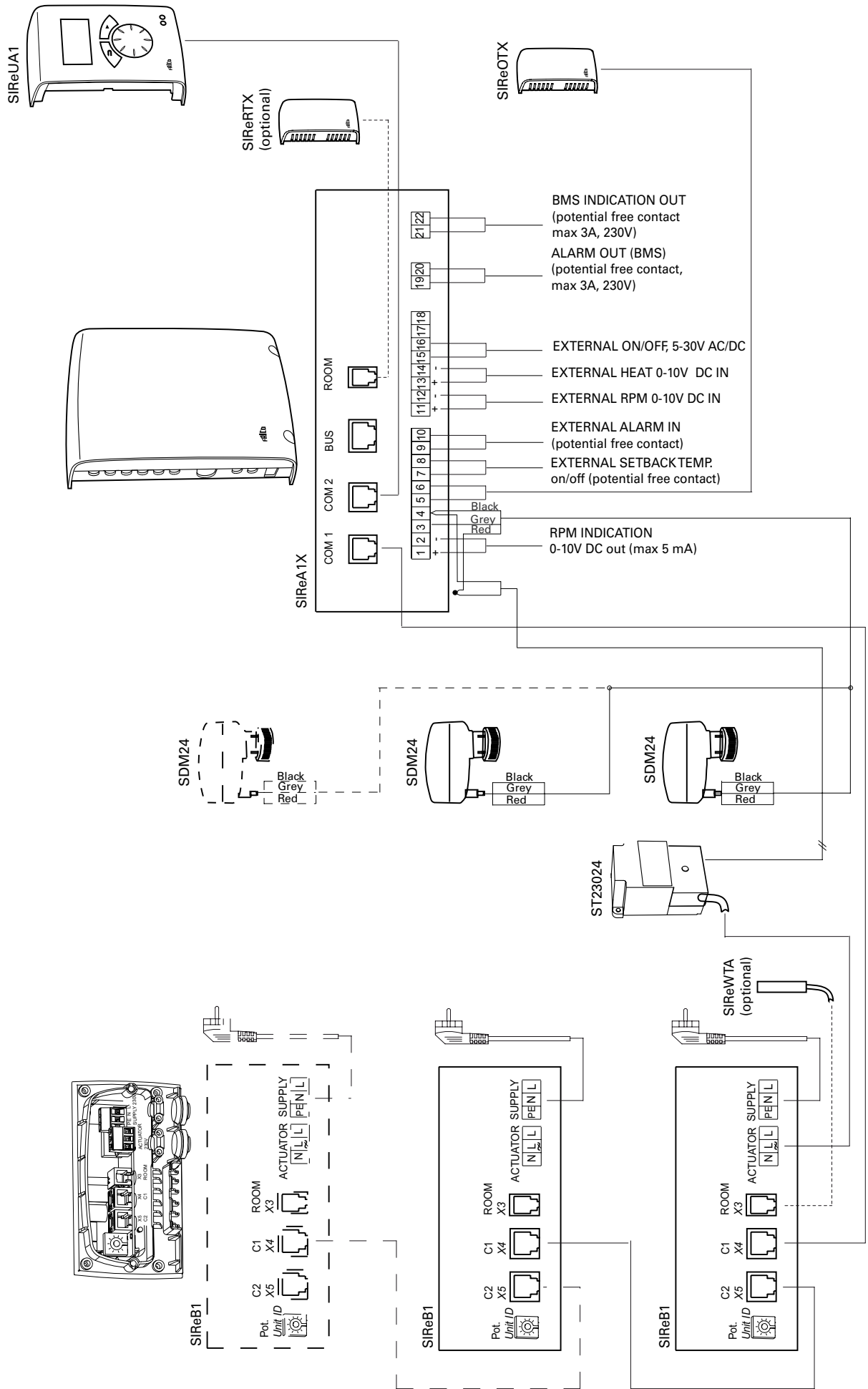

Main office

Frico AB
Box 102
SE-433 22 Partille
Sweden

Tel: +46 31 336 86 00
Fax: +46 31 26 28 25
mailbox@frico.se
www.frico.se

**For latest updated information and information
about your local contact: www.frico.se**