

DVV/DVVI-XS, XM, XL, XP

Installation and Operating Instructions for

■ English original version



Previous issues:

IMO_DVV_XS_XL-dt-en_07_10_2013

IMO_DVV-dt-en-se-ru_15_01_2014

IMO_DVV_T_06_11_2012

IMO_DVV_en_18_08_2015-Am_23_12_2015

IMO_DVV_en_13_02_2017_Am_10_05_2017

- Changed service switches up to 4 kW

- Changed standards and Declarations of conformity

The data stated in these operating instructions are merely for the purpose of describing the product. Information about a certain property or suitability for a certain purpose of use cannot be derived from our information. The information does not release the user from his own assessments and examinations.

Please consider the fact that our products are subject to a natural wear and ageing process.

All rights are with Systemair, also for the event of applications for protective rights.

Any powers of use, such as copying and forwarding rights, are with us.

An exemplary configuration has been shown on the title page. The product supplied can therefore deviate from the illustration. The original operating instructions have been written in English language.

Contents

1	General information	4	8.2	Safety elements.....	11
1.1	List of information	4	8.3	Commissioning.....	11
1.1.1	Specific safety symbols	4	9	Operation	11
1.1.2	List of instructions for action	5	9.1	Safety notes	11
1.2	Notes on the documentation.....	5	9.2	Operating conditions.....	12
2	Important safety information	5	9.3	Operation/use	12
2.1	Safety notes	5	10	Maintenance/troubleshooting	13
2.2	Personnel	5	10.1	Malfunctions and troubleshooting (generally)	14
2.2.1	Mounting personnel	5	10.2	Cleaning.....	14
2.2.2	Work on the electrical equipment.....	5	10.3	Maintenance, service	14
2.2.3	Personnel for operation/use, maintenance and cleaning.....	6	10.4	Spare parts	15
2.3	Intended use	6	11	Uninstalling/dismounting	16
2.4	Improper use	6	12	Disposal	16
3	Warranty	6	12.1	Disposal of the fan	16
4	Transport, storage	7	12.2	Disposal of packaging.....	16
4.1	Transport	7	Appendix 1: Dimensions	17	
4.2	Storage.....	7	Appendix 2: Installation examples	18	
5	Description	8	Appendix 3: Installation faults	19	
5.1	Technical data	8	Appendix 4: Wiring diagrams	20	
5.2	Dimensions	8	Appendix 5: Connection possibilities	21	
6	Installation	8	EC-Declaration of Conf. DVV/DVVI F400, F600	22	
6.1	Safety information	8	EC-Declaration of Conf. DVV/120, DVV/T	23	
6.2	Preconditions for installation.....	9	UKCA-Decl. of Conf. DVV/DVVI F400, F600	24	
6.3	Installation	9	UKCA-Declaration of Conf. DVV/120, DVV/T	25	
7	Electrical connection	9			
7.1	Residual current circuit breaker	10			
7.2	Connection of thermal protection	10			
8	Commissioning	10			
8.1	Preconditions	10			

1 General information

1.1 List of information



DANGER

Direct danger

Failure to comply with this warning leads directly to death or to serious bodily harm.



WARNING

Possible danger

Failure to comply with this warning potentially leads to death or to serious bodily harm.



CAUTION

Hazard with a low risk

Failure to comply with this warning potentially leads to moderate injuries.

ATTENTION

Hazard with risk of property damage

Failure to comply with this warning leads to property damage.



NOTE

Useful information and notes

1.1.1 Specific safety symbols



DANGER

Hazard of injury from rotating parts, if not covered with protective grid!

This warning identifies situations with a danger for life from touching impeller. Failure to comply with this warning leads to the risk of death or serious injuries.



WARNING

Hazard from electrical current!

This warning identifies situations with a danger for life from electrical current. Failure to comply with this warning leads to the risk of death or serious injuries.



WARNING

Hazard from bursting parts!

This warning identifies situations with a danger from bursting parts. Failure to comply with this warning potentially leads to the risk of serious injuries.





WARNING

Hazard from hot surface!

This warning identifies situations with a danger from overheating. Failure to comply with this warning potentially leads to property damage.

1.1.2 List of instructions for action

Instruction for action

-  Carry out this action.
-  (if applicable, further action)

1.2 Notes on the documentation



WARNING

Hazard as a result of improper dealing with the fan

These operating instructions describe safe use of the device.

- Read the operating instructions carefully! The personnel dealing with the fan must read and understand the operating instructions.
- Keep the operating instructions with the device. They must be permanently available at the place of use.

2 Important safety information

2.1 Safety notes

Designers, installers and operators are responsible for the **proper mounting and intended use**.

- Only use the fan in a proper condition.
- Provide generally prescribed electrical and mechanical protective devices.
- During mounting, commissioning, maintenance and control, secure the place of mounting against unauthorised access.
- Observe rules for safe work. Protective working gloves, protective working shoes, safety goggles, safety helmet are part of personal protective equipment. Depending on object, additional protective equipment may be necessary.
- Safety components must not be by-passed or put out of function.
- Keep all the warning signs and nameplates on the fan complete and readable.
- Regularly instruct the personnel about safety-conscious behaviour. Requirements for personnel – see 2.2. The appliance is not to be used by persons (including children) with reduced physical, sensory or mental capabilities.



NOTE

We have carried out a risk assessment for the fans. However, it can only apply to the fan itself. After installation of the fan, we recommend to carry out a risk assessment for the whole system. In this way, you have the guarantee that there is no risk potential from the system. Compliance with EMC Directive 2014/30/EC only relates to these products when they have been connected directly to the customary power supply.

2.2 Personnel

2.2.1 Mounting personnel

- Mounting may only be carried out by trained, qualified personnel.

2.2.2 Work on the electrical equipment

- Work on the electrical equipment of the fan may only be done by a qualified electrician or electro technically educated person. This person must know the relevant safety rules to recognise and avoid potentially risks.

2.2.3 Personnel for operation/use, maintenance and cleaning

- Operation/use, maintenance and cleaning may only be carried out by trained and authorized personnel. The operating personnel must have appropriate knowledge about handling with the fan. In the case of a malfunction or an emergency, they must react correctly and adequately.

2.3 Intended use

DVV/DVVI (I = sound insulated) fans are intended for installation in ventilation systems, outside buildings only (on roofs). They may be installed either in duct systems or as a free sucking fan over a nozzle and a sucking side protection grid.

- DVV/DVVI fans are suitable for extraction of clean air, air with a low dust and grease content, media up to max. density of 1,3 kg/m³ and permissible moisture of max. 95 %.
- The maximum permissible operating data on the name plate apply for an air density $\rho = 1,2 \text{ kg/m}^3$ (sea level) and a maximum air moisture of 80 %.
- Daily ventilation of medium -20 up to 120°C, continuous operation. On request motors can be equipped with electric heaters to meet lower temperatures.
- **Smoke and heat extract roof fans DVV, DVVI/F400 respectively F600** are intended to exhaust hot gases up to 400°C/120 min (F400/120, F400/90, F300, F200) respectively up to 600°C/120 min. They are designed for use in powered smoke and heat exhaust ventilating systems in the event of fire, and ventilating in normal conditions (dual use). Ventilated areas and emergency exits contribute to easier evacuation of people and equipment in the event of fire, and to faster and more efficient fire extinguishing; they protect the building structure and equipment against excessive temperatures and decrease fire escalation to the surrounding areas. Snow load classification: SL 0, suitable for installation only on the top of heated buildings, considering possible heat transfer. With FSL accessory installation on top of non-heated buildings up to snow load class SL 1000 is allowed. In case of fire all motor protective devices and controls must be bridged to guarantee functional capability (connection direct to mains).
- *Versions DVV-T and DVV/120 shall be used for common daily ventilation only, not to be used for smoke extraction.*

2.4 Improper use

Above all, the improper use means using the fan in a way other than that described. The following points are improper and hazardous:

- Use of a fan with improper identification (temperature/time class in case of smoke extraction);
- Not suitable to exhaust dust containing medium or medium with such dust concentration, that could affect with dust deposits on operation and explosion protection (appropriate filtering necessary);
- Extraction of grease containing media;
- The fans DVV/F400, /F600, -T, /120 are not intended to exhaust from explosion hazardous zones;
- In case of suction aggressive atmosphere additional acid protection of exposed parts is necessary;
- Not suitable for indoor use;
- Operation without duct system or protective guard (intake protection);
- Operation with the air connections closed;
- Operation without effective thermal protection (PTC).

3 Warranty

Warranty for our products shall be determined according to the contractual agreements, our quotations and, as a supplement, our General terms and Conditions of Business. Warranty claims shall presuppose that the products are correctly connected, operated and used accordingly to data sheets, and regularly maintained.

4 Transport, storage

4.1 Transport

Each fan leaves our plant in an electrically and mechanically proper condition. The fans are delivered in wooden crates. We recommend transporting the fans to the installation site in original packaging.



WARNING

Hazard of impact if the fan falls down!

- Load and unload the fan carefully in order to avoid possible damage.
- Pay attention to the weight and dimensions of the packaging. The weight of the fan is visible from the nameplate.



CAUTION

Danger from cutting edges!

- Wear protective working gloves when unpacking.

 Check the fan for obvious defects, which can impair safe operation.

 First of all, pay attention for defects on the connection cable, service switch and impeller, cracks in the housing, missing rivets, screws or covering caps.



WARNING

Electrical hazard from damaged connection cable or connections

- Do not use the connection cable, service switch or impeller for transport or hoisting.





WARNING

Hazard of impact if the device falls down!

- Transport the device carefully and with appropriate hoisting device!
- Wear a safety helmet and safety goggles!

 Only put the fan at unpacking on its base plate.

 At manual transport observe allowed human lifting respectively carrying forces (see weight on the name plate).

 Avoid impacts and distortion of the base plate and other parts of housing.

4.2 Storage



CAUTION

Hazard due to loss of function of the motor bearings!

- Avoid storing for too long time (recommendation: max. 1 year).
- Turn the impeller manually every three months, wear protective working gloves.
- Before installation, check proper function of the motor bearings

 Store the fan in the original packaging dustproof, dry and protected against weather.

 Avoid effects of extreme heat or cold.

5 Description

The fan structure is completely made of metal parts only. The casing is manufactured from seawater resistant aluminium. The base plate with nozzle consists of pre-galvanized steel. Impellers with backward-curved blades are welded and galvanized respectively made of stainless steel (F600). They are fastened together with hub and secured screw directly on to the motor shaft. Dynamically balanced to BV-3, ISO 14694.

Serially equipped with B5 electric motor 3x400V~, 50Hz, IP 55, insulation class F, with built-in PTC. On request, the fan can be equipped with electric motor intended for other voltage/frequency. Electric motor outside air stream is cooled with fresh air via cooling duct. All sizes are serially equipped with service switch.

Electric motor	Connection	Efficiency class, serially:
Single speed (4 pole, 6 pole, 8 pole)	Y or D	IE2 or IE3
Two speed (4-6, 6-8, 8-12)	Y/Y	IE1
Two speed (4-8, 6-12) Dahlander	YY/Y	IE1

Additional sound attenuator HSDV is available on request, recommended factory mounted as DVVI fan. DVV/DVVI fans can be also equipped with accessory FSL (factory mounted recommended).

5.1 Technical data

Size DVV XS, XM, XL, XP	Max. synchron RPM at 50 or 60 Hz for DVV/F400, DVV/F600**	Max. nominal power at 50 Hz*/**	Impeller diameter	Max. weight** DVV/F400 DVV/F600	Max. sound power level inlet	Max. sound power level outlet***
	min-1	kW	mm	kg	dB(A)	dB(A)
560-XS	1500	2,2	520	102	83	84
560-XM	1500	2,2	570	104	86	87
560-XL	1500	2,2	570	109	90	90
630	1500	5,5	650	168	97	98
800	1500	18,5	820	432	104	106
1000	1500	30	975	548	105	109

* Motor data (input power P1, current, RPM) and data of the fan are visible on the name plate and on the test protocol.
 ** DVV-T and DVV/120 may vary from these data due to special motors
 *** Without HSDV

5.2 Dimensions

Please see Appendix 1 or www.systemair.com.

6 Installation

6.1 Safety information



WARNING

Hazard from falling parts!

- Check the base/roof before installation for load capacity/strength.
- When selecting the hoisting device and fitting material observe the weight, tendency to vibrations and shear forces (weight information on the nameplate).



CAUTION

Danger from cutting edges!

- At installation works wear protective working gloves.

6.2 Preconditions for installation

- DVV fans must be installed on roofs, outside fire zone (DVV/F for exhausting from fire zone).
- The fans must be mounted on a flat, horizontal roof base (<10 mm/m) with height of min. 250 mm over the roof top (motor shaft vertical). The base shall be accordingly designed (load capacity, stiffness, insulation), if not proved Systemair accessories used. Extremely wind or turbulence exposed places should be avoided in order to prevent any water droplets ingress under extreme weather conditions.
- During installation the site must be protected from dust, moisture and weather influences.

6.3 Installation

- Ensure secure access to the fan for maintenance and service.
- Installation examples up to Appendix 2. Installation faults see Appendix 3.
- Fit the contact surface between base plate and roof base with temperature resistant sealing tape for DVV/F or foam sealing tape for DVV/120, DVV-T. Systemair roof bases (for smoke extract fans marked with /F) are delivered with appropriate sealing tape.



WARNING

Hazard from mechanical distortions!

- Before and after mounting check manually if the impeller rotates smoothly. Install the fan only, if the minimum air gap between rotor and nozzle matches the value from the test protocol.
- Avoid distortions of the casing at installation.

- The fans shall be fixed to the base with 4 screws in the corners.
- Ensure unobstructed and uniform intake into the fan as well as free outlet.
- Install connecting ducts and accessories. The suction side of the fan is provided with a connection for flange-type mounting of the air duct according EUROVENT, dimensions see Appendix 1 or www.systemair.com.
- Provide for contact/suction protection and safety distances according to EN ISO 13857.



NOTE

In some cases, it is better to mount accessories before placing the fan on the roof base.



NOTE

It is recommended to install a flexible connection between the fan and duct to avoid eventual tensions or distortions of the base plate (for F400 and F600 only: appropriate flexible connection should take eventual thermal extension of connecting parts. Flexible connection shall comply temperature/time class of the fan (400°C/2h respectively 600°C/2h); also as certified Systemair accessory available).



NOTE

It is recommended to keep sufficient ventilation rate to avoid condensation in cold corners of the roof base under certain weather conditions or to insulate any heat bridge in case of low ventilated buildings.



NOTE

Data of accessories are on-line available - www.systemair.com.

7 Electrical connection

The wiring diagram is placed inside the cover of service switch (also in the test protocol). The quality and installation of cables for electrical connection must ensure uninterrupted energy supply, even in case of fire. Inside fire zone use

only certified cable. The electric cable must not be in contact with or be fastened to the casing of the fan (F400, F600 only, high temperature!). Connecting possibility see Appendix 5. Electrical data on the fan nameplate must comply with the provided mains connection. Equivalent motors from different suppliers may have slightly different nominal data than in catalogue.



NOTE

- Motors have serial built-in PTC. More than two PTC chains may not be switched in series, as this can lead to undefined cut-outs.
- Maximum check voltage of PTC is 2,5 V (to reduce influence on the result of measurement).
- The wiring diagram see Appendix 4.
- Motor protection must be provided by the installer.



WARNING

Hazard from electrical voltage!

- Electrical connection only by a trained electrician respectively trained and instructed qualified personnel!
- Electrical connection in accordance with the valid regulations.
- Prevent the ingress of water into the connection box.
- Observe 5 safety rules for the electrical expert!
 - disconnect from the power supply (all-pole),
 - prevent switching on again,
 - test absence of voltage,
 - earthing and short-circuiting,
 - protect adjacent live parts by covers and barriers and fit a suitable warning notice.

- ☞ Connect the cable according to wiring diagram.
- ☞ Tighten the nuts of cable glands well to achieve IP68 protection.
- ☞ Check, if the cover of service switch is uniformly fastened. If there is a danger of unintended switch off of the service switch, it should be locked to guarantee operation in fire case (F400, F600). Drill a hole into the handle in the "on" position and provide with a padlock (not supplied with the fan). See Appendix 4.
- ☞ Place the supply cable.

7.1 Residual current circuit breaker

- ☞ Use universal RCDs type B or B+ in case of speed control with frequency converter.

7.2 Connection of thermal protection



CAUTION

Property damage as a result of motor overheating

- The motor can overheat and be destroyed if the PTC not been connected.
- PTC always connect to a motor protective device!

8 Commissioning

8.1 Preconditions

- Mounting and electrical connection have been correctly performed.
- Installation residuals and foreign objects have been removed from the fan and ducts.
- Inlet and outlet are free.

- The safety devices have been fitted (protection against contact with rotating impeller).
- The protective conductor and external earth conductor have been connected.
- The thermal protection is properly connected to the motor protective device:
 - the motor protective device is functional;
 - the thermal protection is functional.
- The cable glands are tight.
- Provided mains connection complies with the data on the nameplate.
- The current (from the nameplate) does not exceed the mains data.

8.2 Safety elements



DANGER

Hazard from injury from rotating parts, if not covered with protective grid!
The outlet protective grid is serially provided.

 Check if the safety elements e.g. protective grids are fastened.

8.3 Commissioning



WARNING

Hazard from electrical voltage!

- Commissioning by trained and instructed qualified personnel only!

 Switch the ventilator on as planned.



WARNING

Hazard from bursting parts!

- When checking the direction of rotation, wear safety goggles.

 Check:

- the direction of rotation (all speed!). Switch the fan for a short period on and then off to check the direction of rotation of impeller. It is visible through a hole on the casing. **The rotation must comply with the arrow on the casing.** If wrong, swap two phases.
- leave the fan running, check, if running smoothly (eventual vibrations and noise);
- measure current with appropriate instrument (it may exceed nominal current by a max. 5%);
- tightness of all joints.

 Fill in the attached test protocol of the fan and submit it in case of warranty claim.

9 Operation

9.1 Safety notes



WARNING

Hazard from electrical voltage!

- The device may only be operated by persons
 - instructed in function and risks,
 - who have understood handling and can accordingly react.
- Ensure access only to persons, who can safe handle the device.

9.2 Operating conditions

- During operation, touching the impeller must not be possible.
- Safety components must not be bypassed or put out of function.
- Prevent sucking of foreign particles, this can destroy the fan.
- Switching frequency:
 - the fan is intended for S1 continuous operation!
 - the control equipment must not allow any extreme switching!
- **The fan may operate only within the limits declared on the nameplate.** Operation above 50 Hz is allowed for the fans accordingly designed and marked on the nameplate. The DVV/F400, F600 fan may be approved for 60 Hz operation, if synchronous speed at 60 Hz does not exceed the data from the table in section 5.1.
- **If the fan is used for smoke and heat extract (F400, F600) in case of fire bridging of motor protective devices is necessary to assure operation. Switch on max. speed even after eventual short supply cut off must be assured.**
- The fans were hot tested with frequency converter and without filter. However, it is recommended to bridge eventual converter in case of fire (to prevent any error at motor protection setting or operation). **If frequency converter is used in case of fire, PTC and any motor protection must be bridged and switch on max. speed even after eventual short supply cut off assured.**
- In case of speed control via frequency converter - min. 20 Hz ÷ max. 50 Hz (rsp. 60 Hz, if declared for 60 Hz), it is recommended use of combination of frequency converter and appropriate all-pole sine filter (or dU/dt filter). It is particularly important, if the supply cable is long, but also to reduce the motor noise. Filters may only be abandoned, if proven, that the voltage peaks on the connection terminals of the fan are inside stress category B-C (moderate-severe) up to EN 60034-18-41. Practically, the peaks shall be lower than limits U_{LL} 2550 V, U_{LG} 1800 V and the rise time longer than 0,5 μ s. Not observing this, the motor life time could be shorter.

ATTENTION

Hazard with risk of additional costs



- At frequency controlled units additional EMC protection of cable from motor to service switch and service switch itself could be needed (on request). Some single speed items F400 and /120 in the range 7,5 to 30 kW with EMC protection are already serially available – marking EMC.
- Subsequently fitting of EMC shielded cable from motor to connection box/service switch is connected with disassembly of the fan!
- In the DVV fans there are not any two speed motors in Y230V/D400V connection built-in; two speed motors are only in Y400V/Y400V or Y400V/YY400V connection.
- Small single speed motors (Y400V) are in motor connection box connected in Y ; it is impossible to change the connection to D230V without disassembly of the fan (for eventual 3x230V frequency converter).



NOTE

At single speed motors with nominal power from incl. 5,5 kW (D400V) we recommend “star – delta” starting. For this purpose all 7 wires are led to connection box/service switch. Not applicable at all items with marking EMC, which are intended for frequency converter operation.

9.3 Operation/use

-  Only use the fan in accordance with this operating instruction and the operating instructions of motor.
-  Control the fan during operation for correct function.
-  Switch the fan off as planned.

WARNING

Hazard from electrical voltage and flying parts!
Errors occurring can lead to personal and/or property damage!

Switch the fan immediately off as planned:

- In cases of a non-typical noise from bearings, vibrations, pressure pulsation.
- In case of overcurrent, overvoltage or temperature (nameplate). Then try to find the reason - see chapter 10.

10 Maintenance/troubleshooting

WARNING

Hazard from electrical voltage!

- Trouble setting and service only by a trained electrician or trained and instructed qualified personnel!
- Observe rules for safe work at maintenance/troubleshooting, cleaning and service!
- Observe 5 safety rules for the electrical expert!
 - disconnect from the power supply (all-pole),
 - prevent switching on again,
 - test absence of voltage,
 - earthing and short-circuiting,
 - protect adjacent live parts by covers and barriers and fit a suitable warning notice.

DANGER

Hazard from injury from rotating parts, if not covered with protective grid!

The outlet protective grid is serially provided. If needed to remove protective grids temporarily, assure:

- Electrical circuit must be interrupted and secured against restarting.
- Impeller must stand still.
- Immediately after finished work fix protective grids.

CAUTION

Danger from hot surfaces!

- During maintenance/troubleshooting and cleaning wear protective working gloves to prevent contact with hot motor!

10.1 Malfunctions and troubleshooting (generally)

	Possible reasons	Action
The ventilator does not run	Connection to the mains fault. Thermal protection triggers. Motor fault.	Check connection to the mains and thermal protection. If ok. check electric motor (winding resistance, resistance to ground). If two speed motor (4-6, 6-8, 8-12, 4-8, 6-12) is installed, check all speed. If necessary get the electric motor repaired.
Air volume is too low	Wrong direction of rotation. Too high pressure drop in system. Obstacles in duct.	Check the direction of rotation. If wrong, swap the supply connection of any 2 phases. Check if current is similar all phases. If ok. check operating point and system design.
Thermal protection of the fan switches off	Short-circuit. Damage to the bearings. Impeller blocked or grinding.	Compare connection with wiring diagram. Compare the data of electric motor with setting of thermal protection. If ok. check power supply and electric motor. Get the electric motor or if necessary the complete fan repaired.
	Overcurrent	Check the direction of rotation. If wrong, swap any 2 phases. Check if current is similar all phases.
Noise	Damage to the bearings. Impeller blocked or grinding.	Get the electric motor or if necessary the complete fan repaired.
	Loose fit on the base plate or motor support.	Tighten the bolts, look for the cause of vibrations.
Vibrations	The actual pressure drop of the system is higher than supposed, the fan could operate in an unstable area of the fan curve.	Check operating point and system design. Consult customer service of the manufacturer.
	Damage or dust layer on impeller.	Clean the impeller, if necessary balance it or replace it.

If the reason for malfunction cannot be clearly determined, consult the customer service of manufacturer.

10.2 Cleaning

Regular cleaning prevents unbalance.

-  Keep casing and impeller clean and clean them if necessary with a brush (do not use a steel brush or high-pressure cleaner). Do not use any detergents for interior cleaning. Regular cleaning is particularly important, if there are trees in the neighbourhood. The gap between casing and base plate must be kept free for water drain and may not be covered by needles or leaves.

10.3 Maintenance, service

Basically the fan may be repaired at the manufacturer only! Exceptions are non-relevant components. For further instructions consult the manufacturer.

The fan is by built-in for-life lubricated ball bearings as far as possible low-maintenance product. After their life time (app. 30.000 – 40.000 h), a replacement of the bearings is necessary. Observe attached instructions of motor manufacturer.

-  Pay attention to a non-typical noise from bearings.

-  For damages (e.g. damage to winding) please contact our Service Department. You will find the address on the back of these operating instructions.

Maintenance and check points of fans similarly to VDMA 24186-1 (type, scope and maintenance intervals to be specified in dependence of use and operating conditions).

VDMA 24186-1	Description	Maintenance interval		
		Monthly	Every 3 months	Once a year
	Fan and electric motor of the fan			
1.1.11	Check the drainage for function			x
6.1.1	Check to dirt, damage, corrosion and fastening		x	
6.1.2	Functional cleaning			x
10.1.6	Check the terminals for tightness			x
10.1.9	Test the fan for function und operational readiness (test run app. 15 min.)		x	
6.1.4	Check the bearings for noise			x
10.1.3	Check impeller for direction of rotation (all speed)			x
6.1.3	Check impeller if damaged or unbalanced (if necessary provide vibration measurement)			x
10.1	Functional test of automatically bridging of all thermal and overcurrent protective devices		x	
10.1.7	Measure the current			x
10.1.12	Test function of protective device		x	
	Triggering device			
	Check it for function	x		
	Test of functions			
	Test all functions of system from control panel as well as signal lights	x		
	Test of hatch opening/closing			
	Check the joints of actuator and hatch cover are properly fastened		x	
	Check if smoothly opens/closes		x	
	Check the safety measures (protective elements, signs, guards)		x	
	Accessories (air ducts, air louvers, flaps, sound attenuators)			
5.5.1	Check accessible ducts inclusive fire protective insulation and fastening for outside damages and corrosion (visually)			x
5.5.4	Check accessible flexible connections for tightness (visually)			x
5.2.1 5.2.3	Flaps and sound attenuators check for dirt, damage and corrosion			x
5.1.1	Check mechanical functionality of the flaps			
5.1.1	Check air louvres for dirt and damage (visually)			x

10.4 Spare parts

In case of order of spare parts please specify the serial number of the fan. You can find it on the nameplate or in the test protocol.

Spare parts: electric motor (there is a restriction to use only from the test lab allowed motors), impeller, service switch, casing.

How to replace electric motor, impeller or actuator - please contact manufacturer for instructions.

11 Uninstalling/dismounting



WARNING

Hazard from electrical voltage!

- Disconnection and uninstalling only by a trained electrician or trained and instructed qualified personnel!
- Observe 5 safety rules for the electrical expert!
 - disconnect from the power supply (all-pole),
 - prevent switching on again,
 - test absence of voltage,
 - earthing and short-circuiting,
 - protect adjacent live parts by covers and barriers and fit a suitable warning notice.



CAUTION

Danger from cutting edges and impact!



- Wear protective working gloves when dismantling!
- Dismount carefully.



WARNING

Hazard from falling parts!



- When selecting the hoisting device observe the weight (weight information on the name plate).

-  Carefully disconnect all wires.
-  Remove the fan from duct. Carefully remove the fastening material.
-  Lift the fan with an appropriate hoisting device on the provided lifting eyes. Place the fan on appropriate pallet.

12 Disposal

12.1 Disposal of the fan

Should the fan be disposed, proceed as follows:

-  Disassemble the fan into its components.
-  Separate the parts according to
 - reusable material
 - material groups to be disposed (metal, plastics, electrical parts, etc.)
-  Provide for the recycling of material. Consider the national regulation.

12.2 Disposal of packaging

-  Provide for the recycling of material. Consider the national regulation.

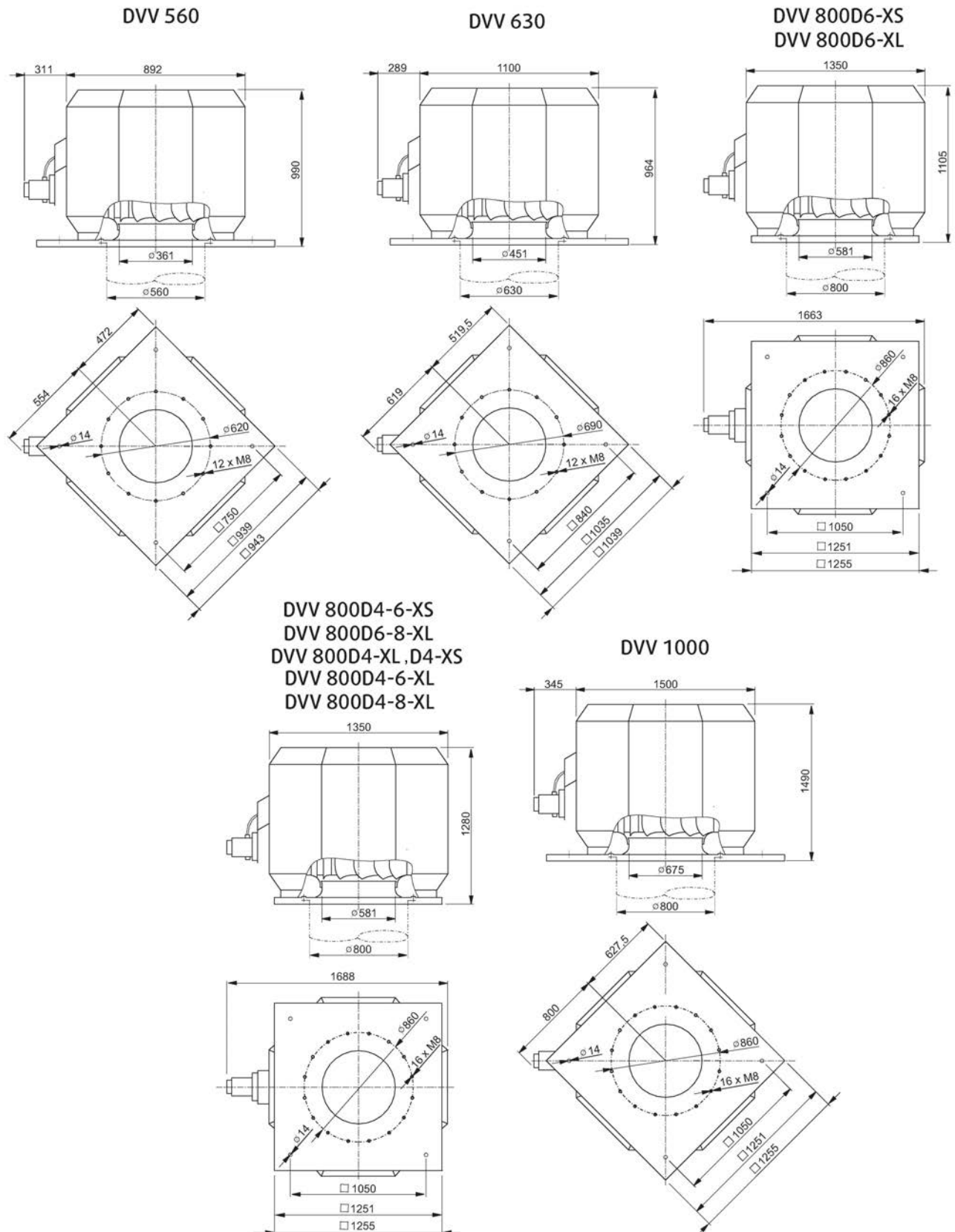

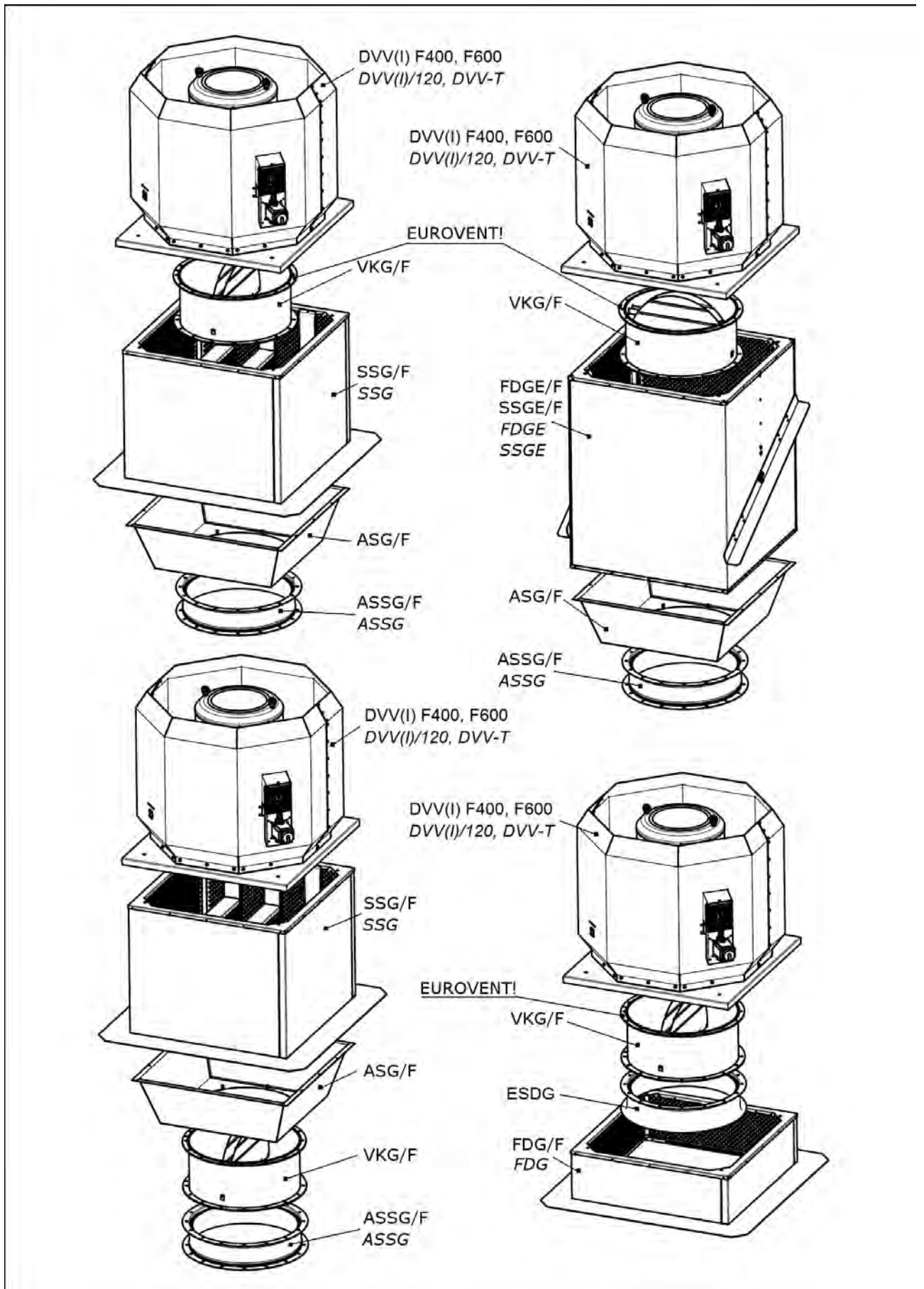

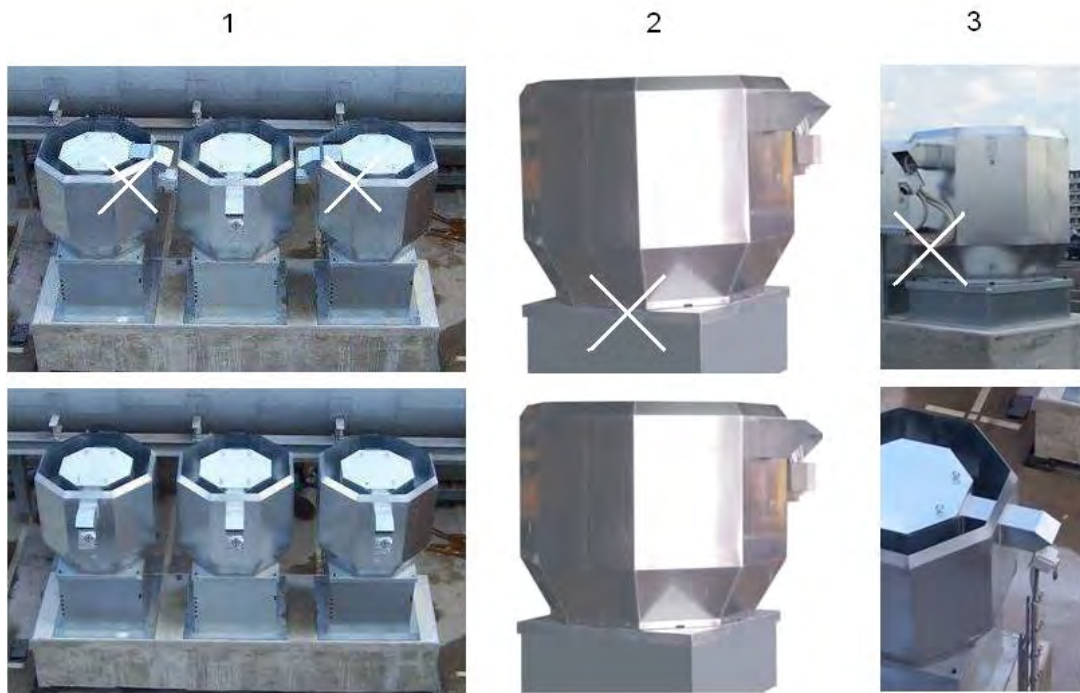

- 1 - Don't turn the cooling ducts towards each other
- 2 - Mount the fan on the horizontal base (base pitch <math>< 10 \text{ mm/m}</math>)
- 3 - Don't fix the cable on the casing

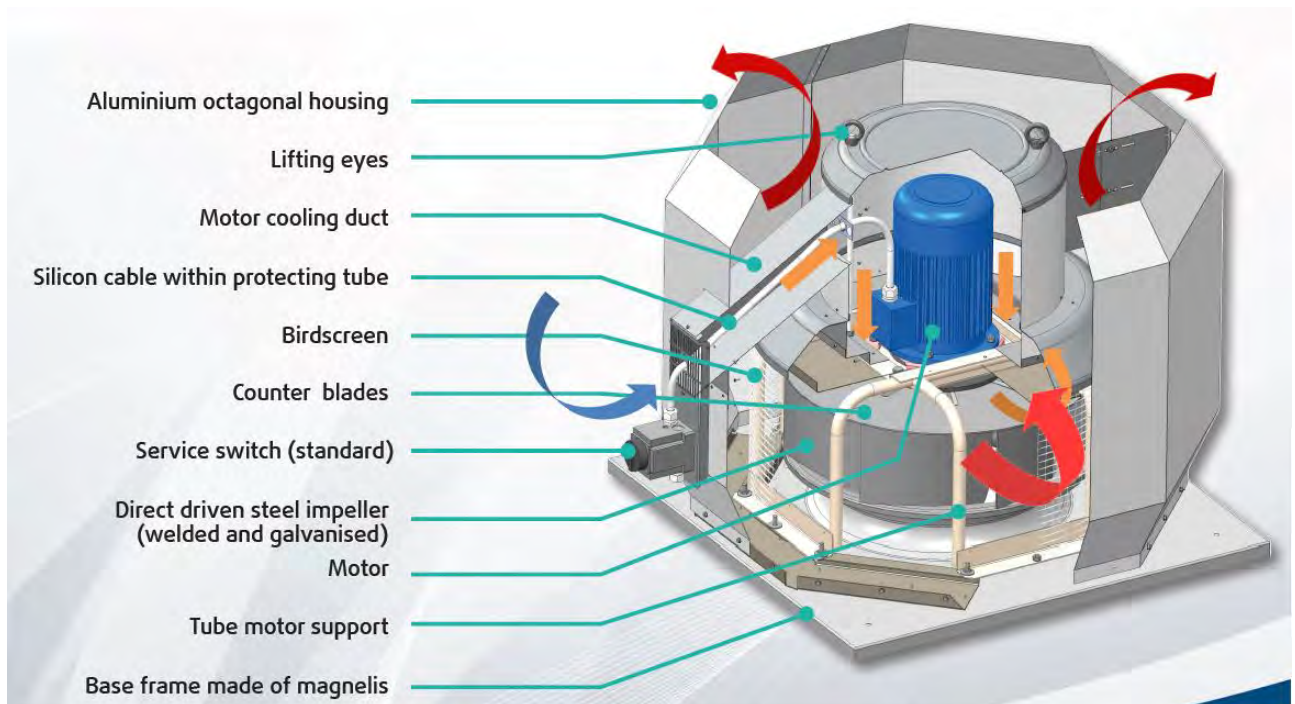

- 4 - Enable free cooling air inlet and free outlet (DVV/F400 shown)

Appendix 4: Wiring diagrams

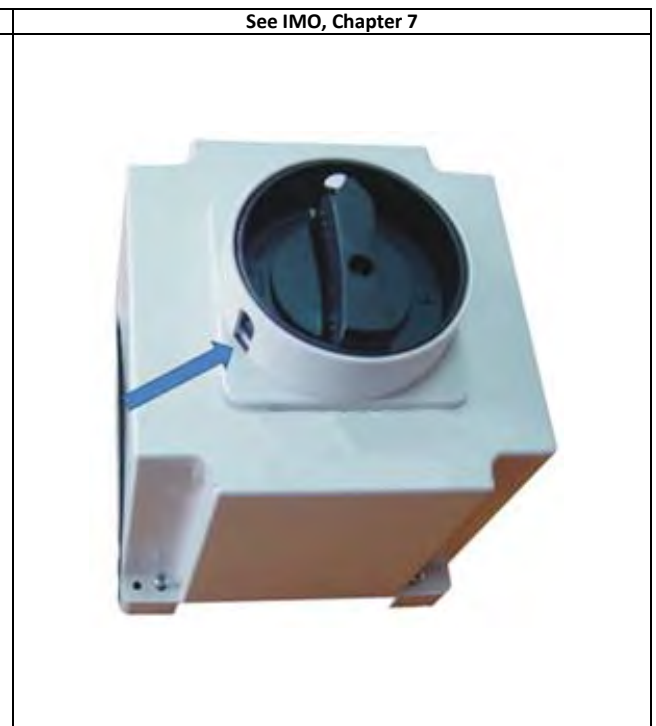
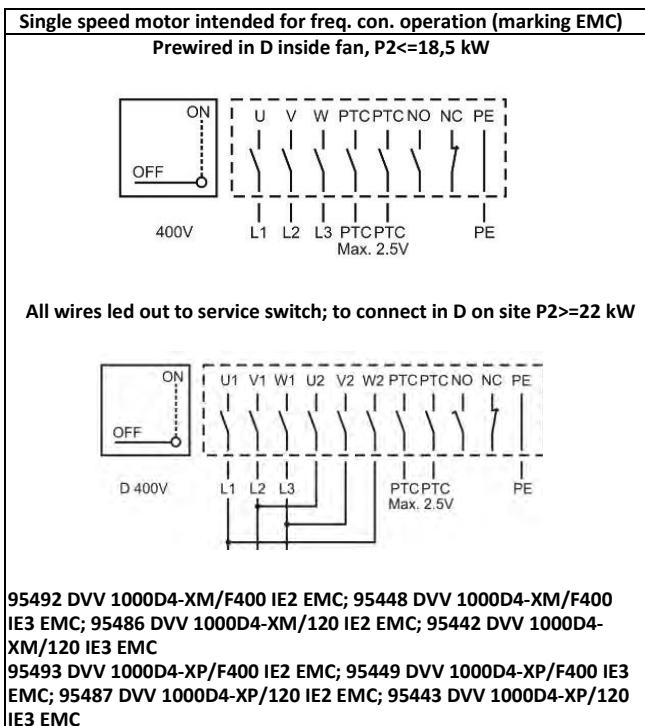
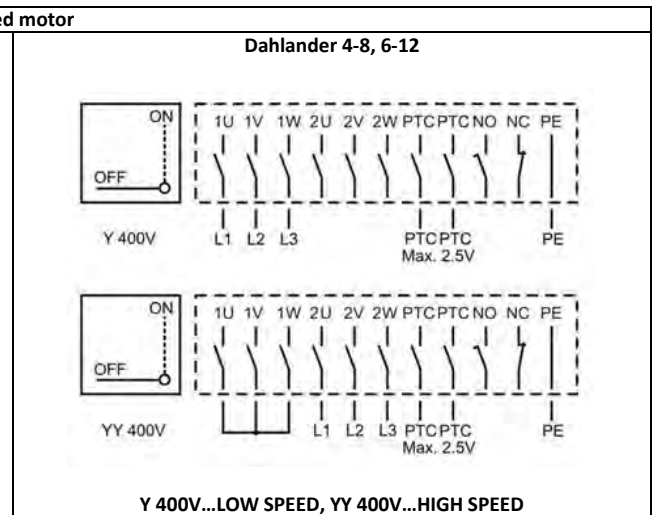
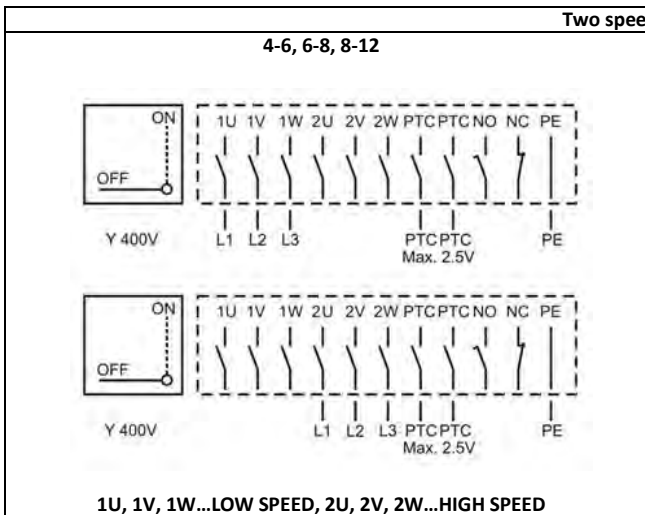
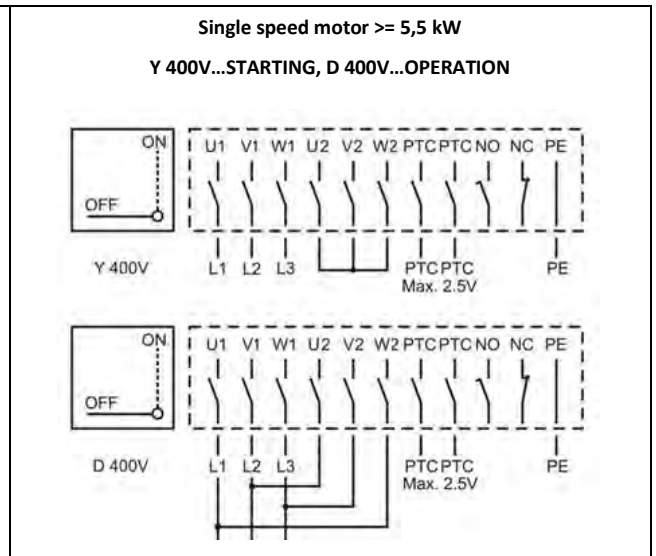
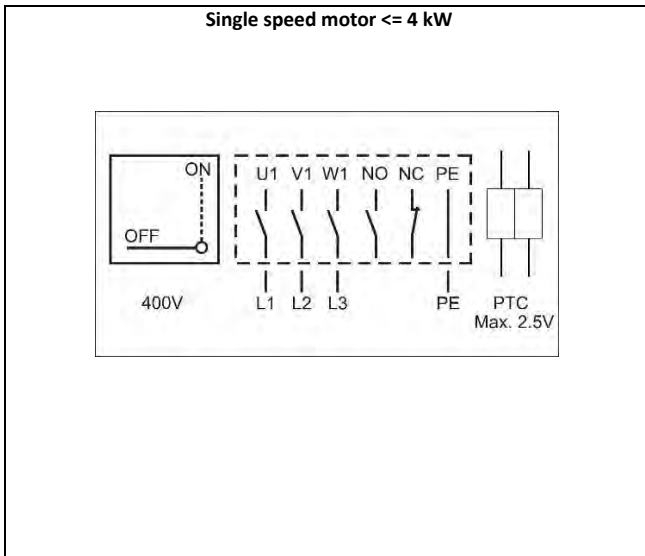



DVV 560
 DVV 630D4-XS
 DVV 630D6-XL
 DVV 800D6-XS

1	M20x1,5	Power supply + PTC	d max. 4 mmq	D max 14,5 mm
2	M12x1,5	-		
3	M20x1,5	-		

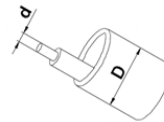

DVV 630D4-XL, 4-6-XL
 DVV 800D6-XL
 DVV 1000D8-XL, XP
 DVV 1000D6-XM, 6-8-XM

1	M25x1,5	Power supply	d max. 4 mmq	D max 16,5 mm
2	M16x1,5	PTC	d max. 1,5 mmq	D max 10 mm
3	M32x1,5	-		

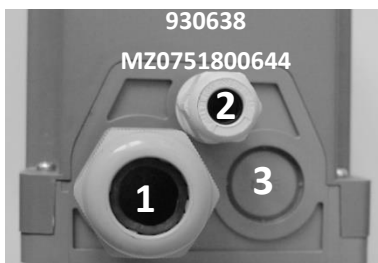
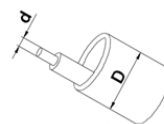

DVV 800D4-XS, 4-6-XS
 DVV 800D6-8-XL
 DVV 1000D6-XL, 6-XP
 DVV 1000D6-8-XL, 6-12-XL

1	M32x1,5	Power supply	d max. 6 mmq	D max 18 mm
2	M16x1,5	PTC	d max. 1,5 mmq	D max 10 mm
3	M25x1,5	-		

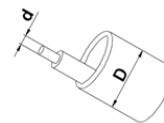

DVV 800D4-XL, 4-6-XL, 4-8-XL
 DVV 1000D4-XM, 4-6-XM, 4-8-XM
 DVV 1000D4-XP, 4-6-XP, 4-8-XP

1	M32x1,5	Power supply	d max. 10 mmq	D max 18 mm
2	M16x1,5	PTC	d max. 1,5 mmq	D max 10 mm
3	M32x1,5 - M40x1,5	-		

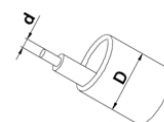

The Manufacturer: **Systemair d.o.o.**
 Špelina 2, SI-2000 Maribor
 Tel.: +386 2 4601 801

<i>Certifies herewith that the following products:</i>	Smoke and heat extract fan*, type DVV/DVVI-XS, XM, XL, XP/F400 DVV/DVVI-XS, XM, XL, XP/F600 DVV/DVVI+FSL-XS, XM, XL, XP/F400 DVV/DVVI+FSL-XS, XM, XL, XP/F600
--	--

ensure all relevant requirements of following directives:

EC Machinery Directive (2006/42/EC)
Electromagnetic compatibility directive (2014/30/EU)
Low Voltage Directive (2014/35/EU)
Regulation (EU) No 305/2011 (CPR)
Commission Regulation (EU) No 2019/1781 (Ecodesign)
Commission Regulation (EU) No 327/2011 (Fans)
Commission Regulation (EU) No 1253/2014

Applied harmonized standards, in particular:

EN ISO 12100	Safety of machinery - General principles for design - Risk assessment and risk reduction
EN ISO 13857	Safety of machinery - Safety distances to prevent hazard zones being reached by upper and lower limbs
EN 60204-1	Safety of machinery - Electrical equipment of machines - Part 1: General requirements
EN 12101-3	Smoke and heat control systems – part 3: Specification for powered smoke and heat exhaust ventilators

*(*complies with the provisions of the Range reports issued by ZAG, Ljubljana, No. P 0722/12-530-3 from 05.03.2013 (F400), No. P 0046/15-530-2 from 27.05.2015 (F600))*

Note1: *Compliance with EC Machinery Directive and EN ISO 13857 refers to the mounted protective guards on the inlet of the fan, as far they are in the extent of delivery. For the fully accordance with mentioned requirements (protective guards or safety assurance in other way) the performer is responsible.*

Note2: *Compliance with EMC Directive 2014/30/EC only relates to this product if it has been connected directly to the customary electricity mains. If this product is integrated into a system or completed and operated with other components (e.g. regulation and control appliances), the manufacturer or operator of the overall system is responsible for compliance with EMC Directive 2014/30/EC.*

Maribor,
 16.08.2021

 Date



 Anton Zupančič, Director

The Manufacturer: **Systemair d.o.o.**
 Špelina 2, SI-2000 Maribor
 Tel.: +386 2 4601 801

Certifies herewith that the following products:

**Thermo roof fan, type
 DVV/DVVI-XS, XM, XL, XP/120
 DVV-T**

ensure all relevant requirements of following directives:

EC Machinery Directive (2006/42/EC)

Electromagnetic compatibility directive (2014/30/EU)

Low Voltage Directive (2014/35/EU)

Regulation (EU) No 305/2011 (CPR)

Commission Regulation (EU) No 2019/1781 (Ecodesign)

Commission Regulation (EU) No 327/2011 (Fans)

Commission Regulation (EU) No 1253/2014

Applied harmonized standards, in particular:

EN ISO 12100	Safety of machinery - General principles for design - Risk assessment and risk reduction
EN ISO 13857	Safety of machinery - Safety distances to prevent hazard zones being reached by upper and lower limbs
EN 60204-1	Safety of machinery - Electrical equipment of machines - Part 1: General requirements

Note1: Compliance with EC Machinery Directive and EN ISO 13857 refers to the mounted protective guards on the inlet of the fan, as far they are in the extent of delivery. For the fully accordance with mentioned requirements (protective guards or safety assurance in other way) the performer is responsible.

Note2: Compliance with EMC Directive 2014/30/EC only relates to this product if it has been connected directly to the customary electricity mains. If this product is integrated into a system or completed and operated with other components (e.g. regulation and control appliances), the manufacturer or operator of the overall system is responsible for compliance with EMC Directive 2014/30/EC.

Maribor,
 16.08.2021

Date



Anton Zupančič, Director

UKCA – Declaration of Conformity

The Manufacturer: **Systemair d.o.o.**
 Špelina 2, SI-2000 Maribor
 Tel.: +386 2 4601 840

<i>Certifies herewith that the following products:</i>	Smoke and heat extract fan*, type DVV/DVVI-XS, XM, XL, XP/F400 DVV/DVVI-XS, XM, XL, XP/F600 DVV/DVVI+FSL-XS, XM, XL, XP/F400 DVV/DVVI+FSL-XS, XM, XL, XP/F600
--	--

ensure all relevant requirements of following directives:

Supply of Machinery (Safety) Regulations 2008
Electromagnetic Compatibility Regulations 2016
Electrical Equipment (Safety) Regulations 2016
Construction Products (Amendment etc) (EU Exit) Regulations 2019
Ecodesign for Energy-Related Products and Energy Information (Amendment) (EU Exit) Regulations 2020

Applied harmonized standards, in particular:

EN ISO 12100	Safety of machinery - General principles for design - Risk assessment and risk reduction
EN ISO 13857	Safety of machinery - Safety distances to prevent hazard zones being reached by upper and lower limbs
EN 60204-1	Safety of machinery - Electrical equipment of machines - Part 1: General requirements
EN 12101-3	Smoke and heat control systems – part 3: Specification for powered smoke and heat exhaust ventilators

*(*complies with the provisions of the Range reports issued by ZAG, Ljubljana, No. P 0722/12-530-3 from 05.03.2013 (F400), No. P 0046/15-530-2 from 27.05.2015 (F600))*

Note1: *Compliance with Supply of Machinery (Safety) Regulations 2008 and EN ISO 13857 refers to the mounted protective guards on the inlet of the fan, as far they are in the extent of delivery. For the fully accordance with mentioned requirements (protective guards or safety assurance in other way) the performer is responsible.*

Note2: *Compliance with Electromagnetic Compatibility Regulations 2016 only relates to this product if it has been connected directly to the customary electricity mains. If this product is integrated into a system or completed and operated with other components (e.g. regulation and control appliances), the manufacturer or operator of the overall system is responsible for compliance with Electromagnetic Compatibility Regulations 2016.*

Maribor,
 22.09.2021

 Date

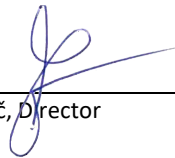

 Anton Zupančič, Director

The Manufacturer: **Systemair d.o.o.**
 Špelina 2, SI-2000 Maribor
 Tel.: +386 2 4601 840

<i>Certifies herewith that the following products:</i>	Thermo roof fan, type DVV/DVVI-XS, XM, XL, XP/120 DVV-T
--	--

ensure all relevant requirements of following directives:

Supply of Machinery (Safety) Regulations 2008
Electromagnetic Compatibility Regulations 2016
Electrical Equipment (Safety) Regulations 2016
Construction Products (Amendment etc) (EU Exit) Regulations 2019
Ecodesign for Energy-Related Products and Energy Information (Amendment) (EU Exit) Regulations 2020

Applied harmonized standards, in particular:

EN ISO 12100	Safety of machinery - General principles for design - Risk assessment and risk reduction
EN ISO 13857	Safety of machinery - Safety distances to prevent hazard zones being reached by upper and lower limbs
EN 60204-1	Safety of machinery - Electrical equipment of machines - Part 1: General requirements

Note1: *Compliance with Supply of Machinery (Safety) Regulations 2008 and EN ISO 13857 refers to the mounted protective guards on the inlet of the fan, as far they are in the extent of delivery. For the fully accordance with mentioned requirements (protective guards or safety assurance in other way) the performer is responsible.*

Note2: *Compliance with Electromagnetic Compatibility Regulations 2016 only relates to this product if it has been connected directly to the customary electricity mains. If this product is integrated into a system or completed and operated with other components (e.g. regulation and control appliances), the manufacturer or operator of the overall system is responsible for compliance with Electromagnetic Compatibility Regulations 2016.*

Maribor,
 16.08.2021

 Date



 Anton Zupančič, Director