

NOVA-PF

Filter Grille for Air Extract

Handbook



Table of Contents

Description3
Dimensions & Weights4
Ordering Codes5
Technical Parameters6
Installation19
Transport, Storage and Operation22
Supplement23

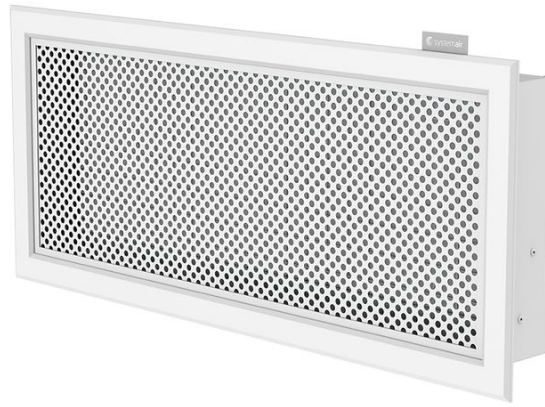

Description

NOVA-PF is a ventilation grille with a filter, for wall or ceiling installation in offices, residential premises or hotels. It is intended for air extract mainly in air re-circulation systems with fan-coils.

Highlights

- Fine aesthetic design and precise finish
- High stability and safety for installation and operation in walls and ceilings in all available sizes
- No tools required for quick and easy access to the filter inlay for cleaning and maintenance

Design

NOVA-PF is composed from two main parts. The wall or ceiling mounting frame from galvanized steel with detachable mesh screen and filter inlay. The detachable front grille with the frame and perforated sheet metal panel. The filter in class "coarse 65 %" is accessible without tools. For this the front grille, that is kept in the frame by spring clips, can be easily opened or removed.

Dimensions & Weights

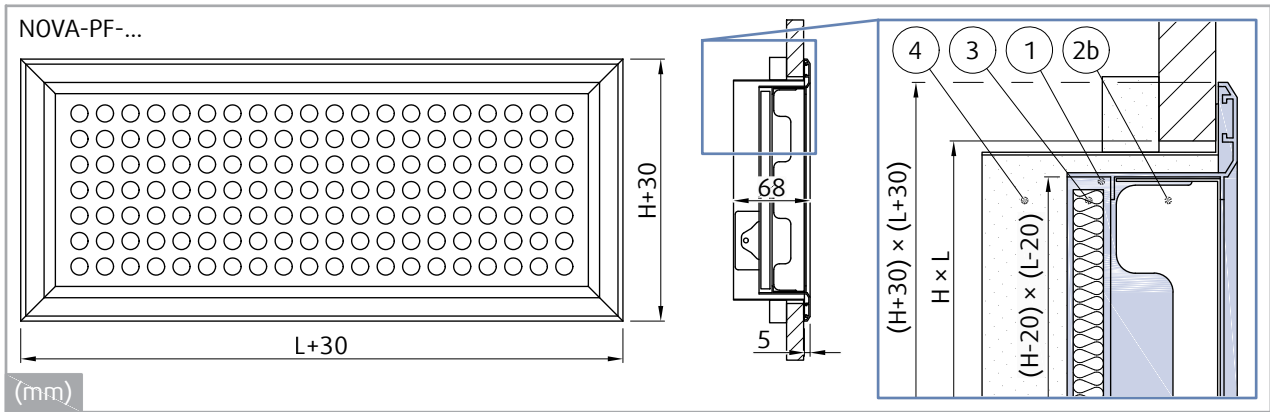

Legend

- 1 Grille frame
- 2b Perforation
- 3 Filter - class Coarse 65%
- 4 Mounting frame

		NOVA-PF-...															
		L (mm)															
m (kg)		200	225	300	325	400	425	500	525	600	625	800	825	1000	1025	1200	1225
H (mm)	100	0,3	-	1,0	-	1,1	-	1,2	-	1,4	-	1,7	-	1,9	-	2,1	-
	125	-	0,6	-	0,9	-	1,0	-	1,4	-	1,6	-	1,8	-	2,1	-	2,3
	150	0,5	-	1,3	-	1,3	-	1,6	-	2,0	-	2,2	-	2,4	-	2,6	-
	200	0,7	-	1,4	-	1,6	-	1,8	-	2,2	-	1,8	-	3,2	-	3,3	-
	225	-	0,9	-	1,6	-	1,7	-	2,2	-	2,4	-	3,1	-	3,5	-	3,6
	300	-	-	1,6	-	2,1	-	2,4	-	2,7	-	3,4	-	4,1	-	3,8	-
	325	-	-	-	1,8	-	2,2	-	2,5	-	3,0	-	3,7	-	4,3	-	4,1
	400	-	-	-	-	2,5	-	2,9	-	3,3	-	5,8	-	4,6	-	4,6	-
	425	-	-	-	-	-	2,7	-	3,2	-	3,5	-	4,0	-	5,1	-	5,2
	500	-	-	-	-	-	-	3,3	-	3,8	-	4,3	-	5,7	-	5,5	-
	525	-	-	-	-	-	-	-	3,5	-	3,9	-	4,4	-	6,2	-	6,1
600	-	-	-	-	-	-	-	-	-	-	-	-	5,8	-	6,2	-	

Ordering Codes

Length (mm) × Height (mm)

Available dimension combinations see in the dimension table.

Surface finish

SW Signal white (RAL9003, gloss 30%)

Example of the Ordering Code

NOVA-PF-500x200-SW

NOVA-PF grille size 500 mm × 200 mm in signal white colour (RAL9003).

Technical Parameters

Pressure drop and radiated sound power level dependent on air flow volume.

NOVA-PF-200x100-SW

Pressure drop & A-weighted sound power level in dB(A)

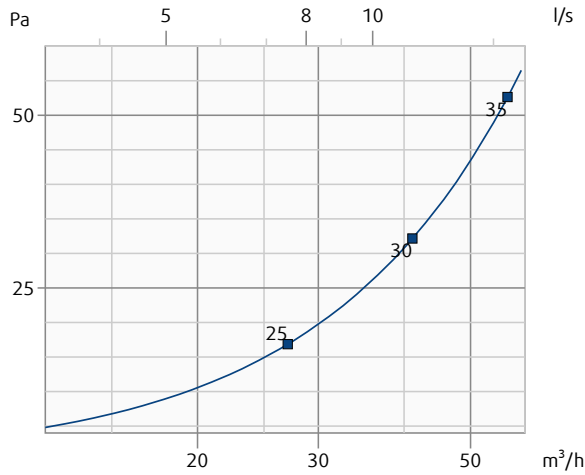

NOVA-PF-200x150-SW

Pressure drop & A-weighted sound power level in dB(A)

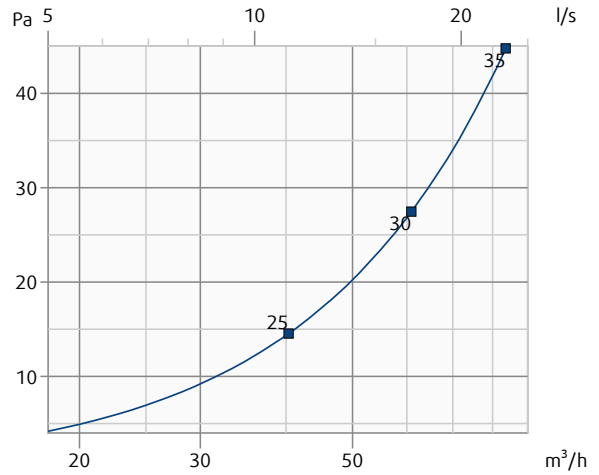

NOVA-PF-200x200-SW

Pressure drop & A-weighted sound power level in dB(A)

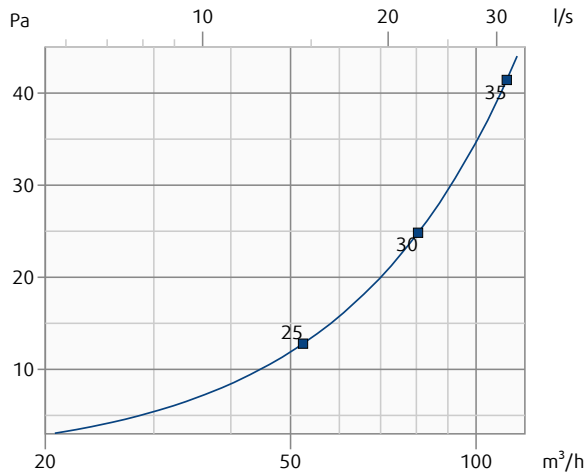

NOVA-PF-225x125-SW

Pressure drop & A-weighted sound power level in dB(A)

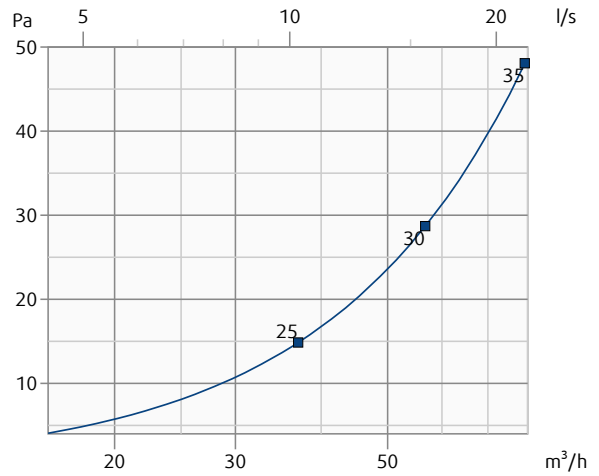

Pressure drop and radiated sound power level dependent on air flow volume.

NOVA-PF-225x225-SW

Pressure drop & A-weighted sound power level in dB(A)

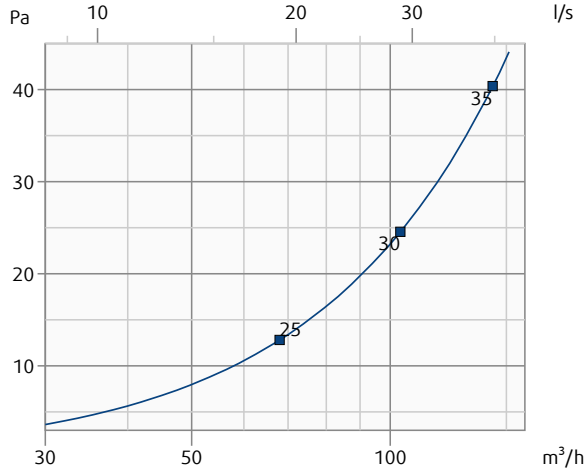

NOVA-PF-300x100-SW

Pressure drop & A-weighted sound power level in dB(A)

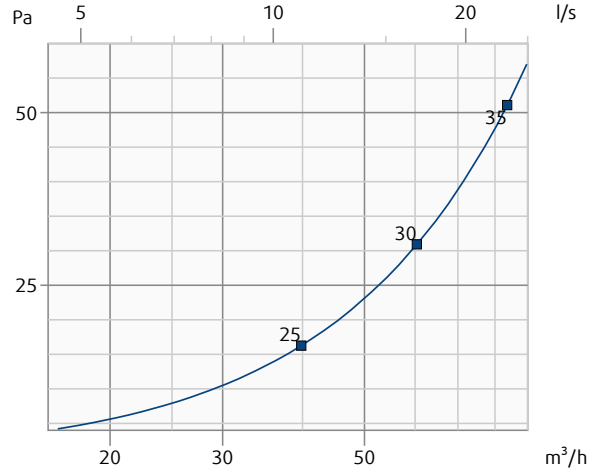

NOVA-PF-300x150-SW

Pressure drop & A-weighted sound power level in dB(A)

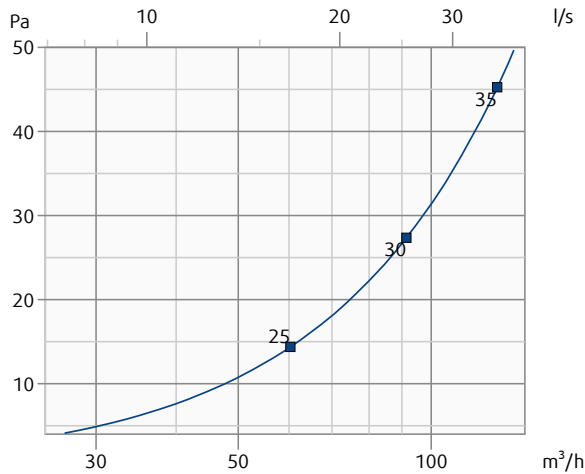

NOVA-PF-300x200-SW

Pressure drop & A-weighted sound power level in dB(A)

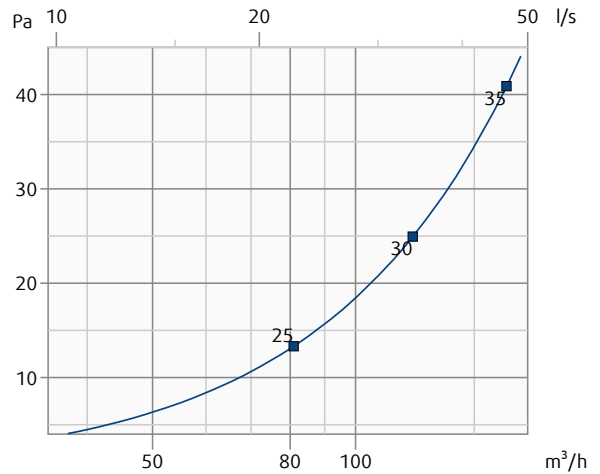

NOVA-PF-300x300-SW

Pressure drop & A-weighted sound power level in dB(A)

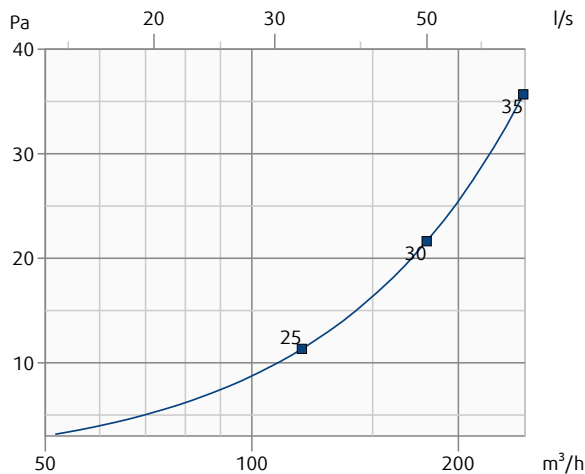

NOVA-PF-325x125-SW

Pressure drop & A-weighted sound power level in dB(A)

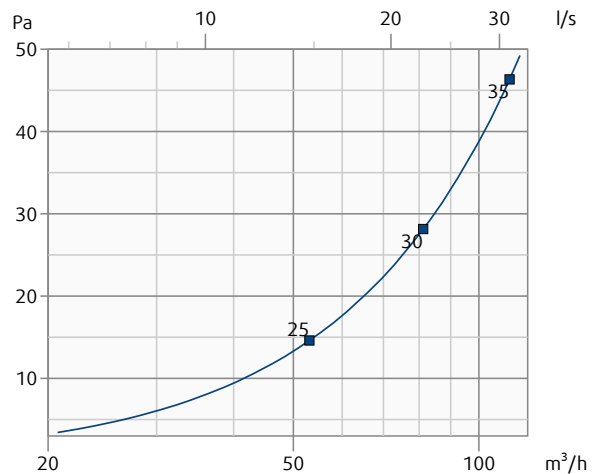

Pressure drop and radiated sound power level dependent on air flow volume.

NOVA-PF-325x225-SW

Pressure drop & A-weighted sound power level in dB(A)

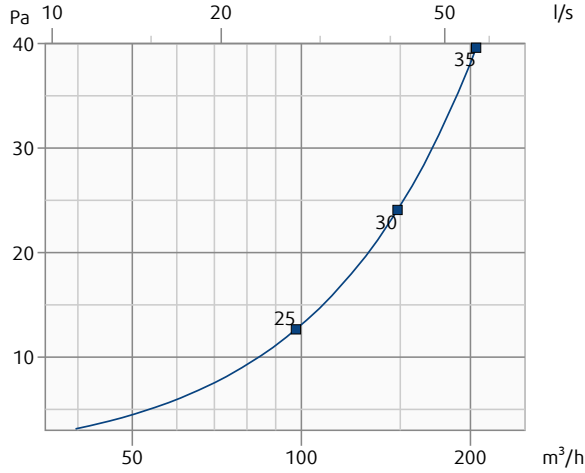

NOVA-PF-325x325-SW

Pressure drop & A-weighted sound power level in dB(A)

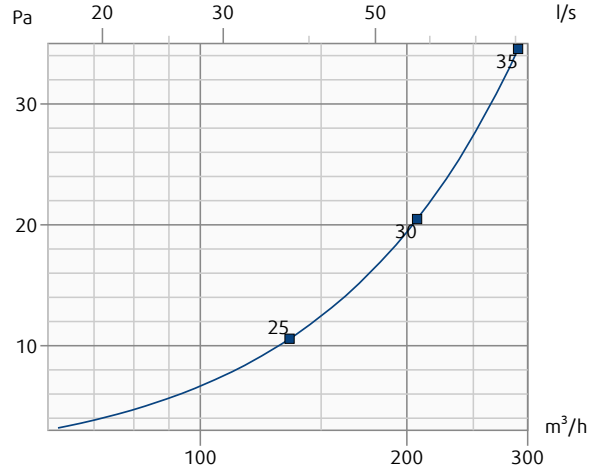

NOVA-PF-400x100-SW

Pressure drop & A-weighted sound power level in dB(A)

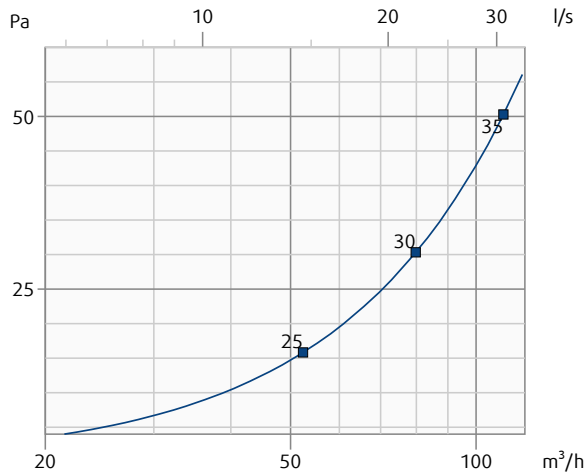

NOVA-PF-400x150-SW

Pressure drop & A-weighted sound power level in dB(A)

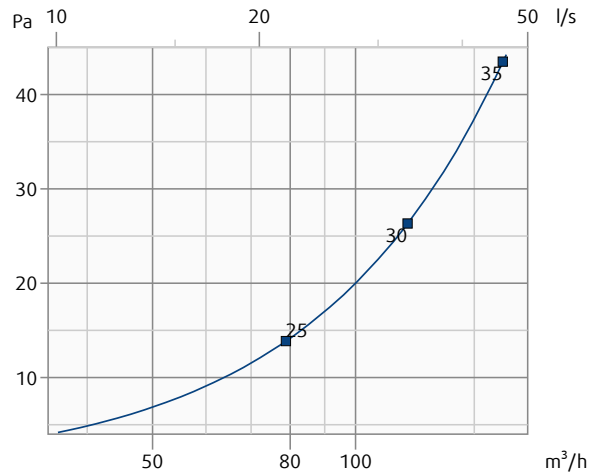

NOVA-PF-400x200-SW

Pressure drop & A-weighted sound power level in dB(A)

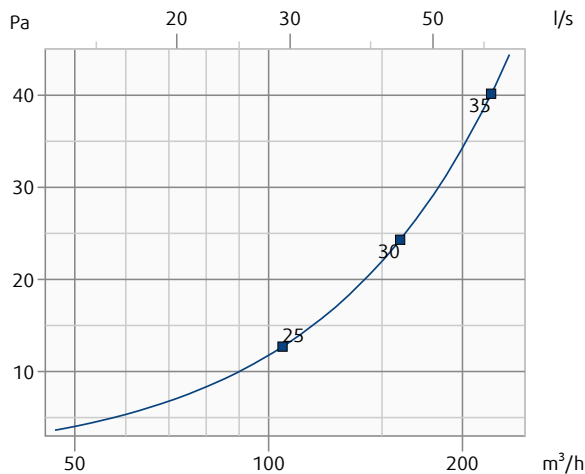

NOVA-PF-400x300-SW

Pressure drop & A-weighted sound power level in dB(A)

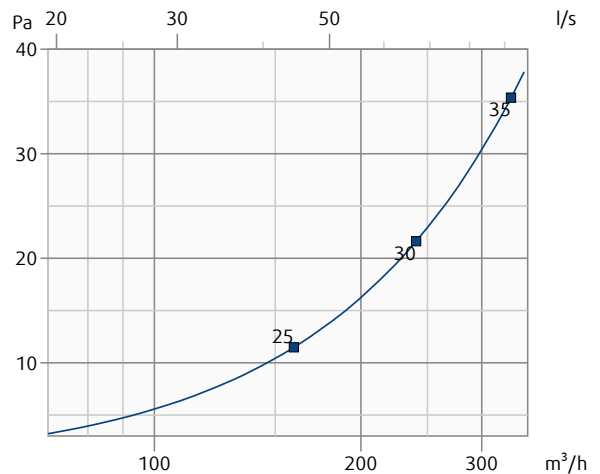

Pressure drop and radiated sound power level dependent on air flow volume.

NOVA-PF-400x400-SW

Pressure drop & A-weighted sound power level in dB(A)

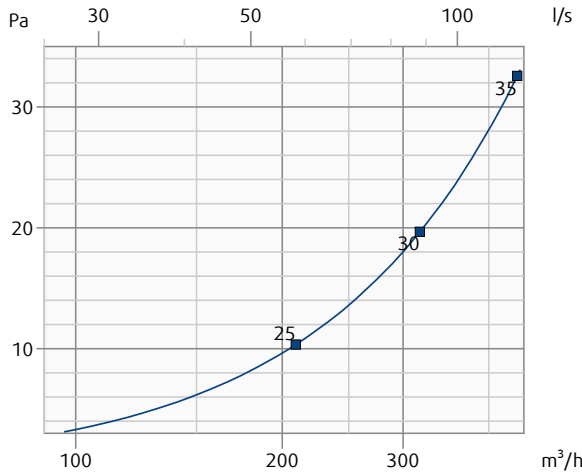

NOVA-PF-425x125-SW

Pressure drop & A-weighted sound power level in dB(A)

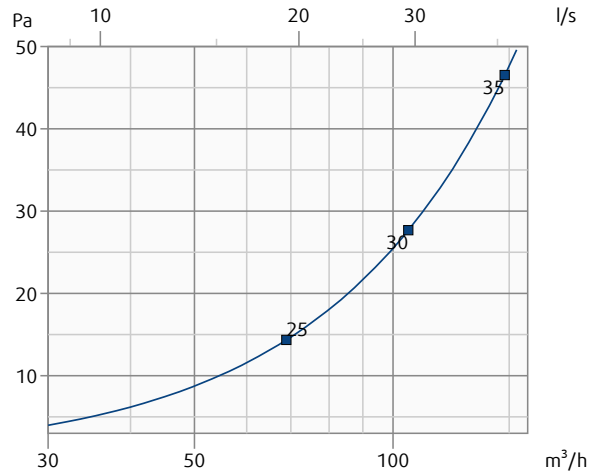

NOVA-PF-425x225-SW

Pressure drop & A-weighted sound power level in dB(A)

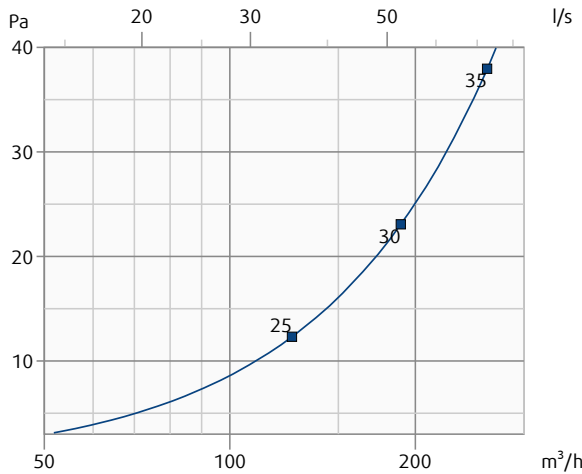

NOVA-PF-425x325-SW

Pressure drop & A-weighted sound power level in dB(A)

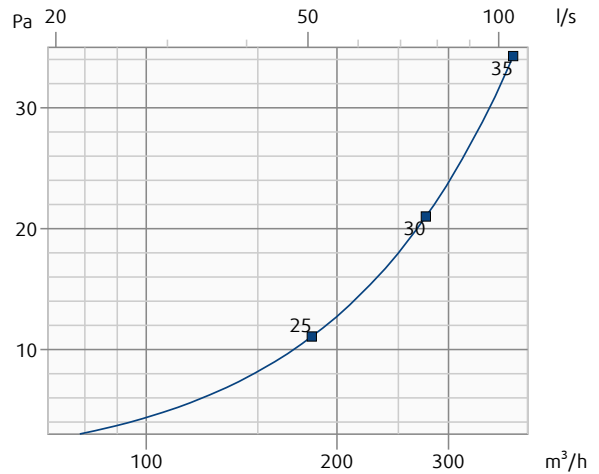

NOVA-PF-425x425-SW

Pressure drop & A-weighted sound power level in dB(A)

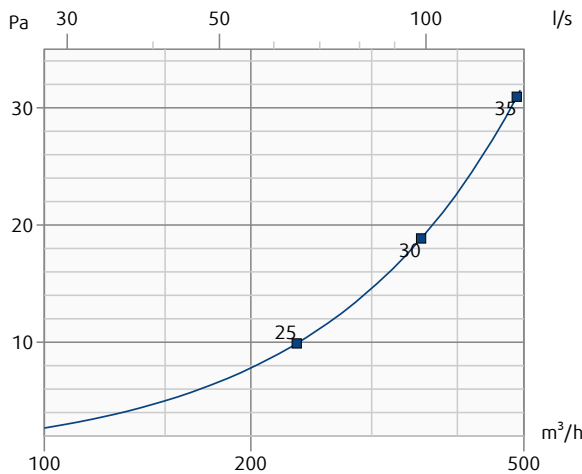

NOVA-PF-500x100-SW

Pressure drop & A-weighted sound power level in dB(A)

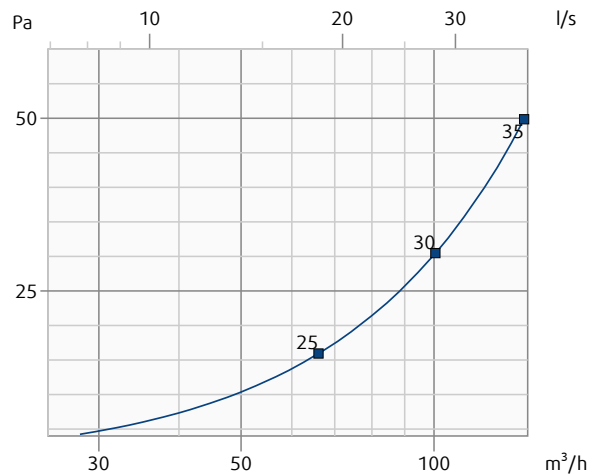

Pressure drop and radiated sound power level dependent on air flow volume.

NOVA-PF-500x150-SW

Pressure drop & A-weighted sound power level in dB(A)

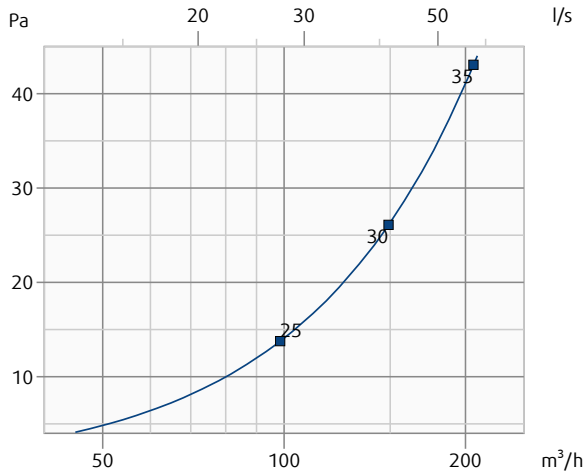

NOVA-PF-500x200-SW

Pressure drop & A-weighted sound power level in dB(A)

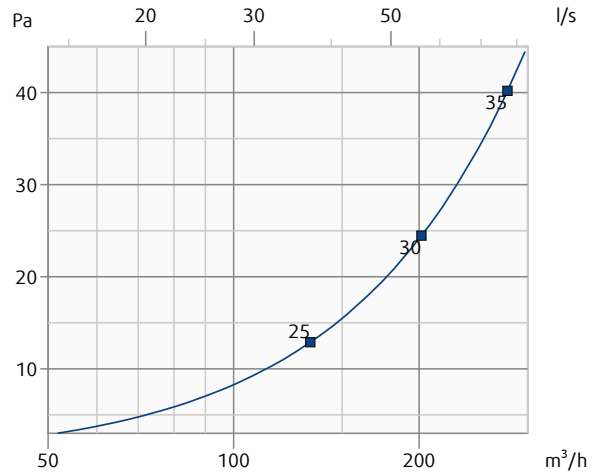

NOVA-PF-500x300-SW

Pressure drop & A-weighted sound power level in dB(A)

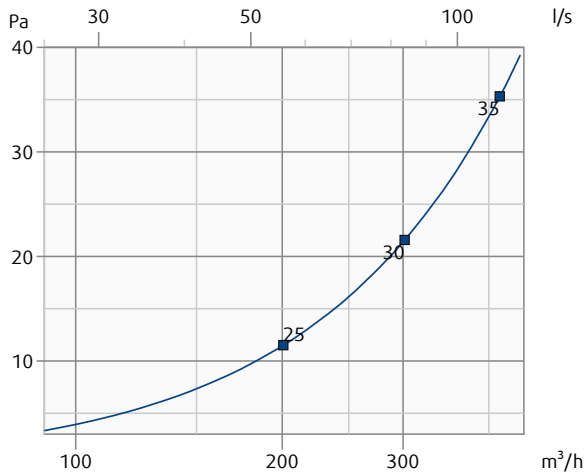

NOVA-PF-500x400-SW

Pressure drop & A-weighted sound power level in dB(A)

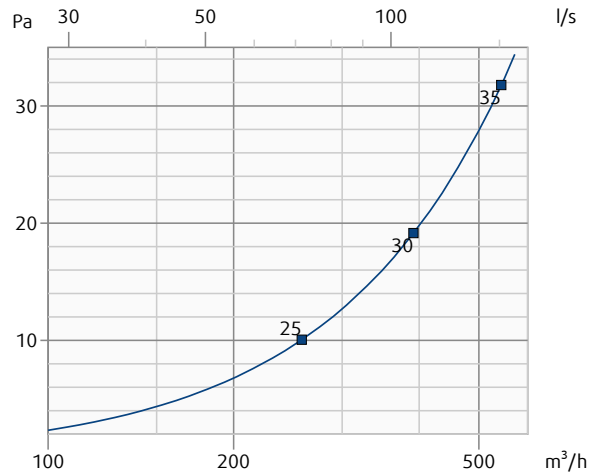

NOVA-PF-500x500-SW

Pressure drop & A-weighted sound power level in dB(A)

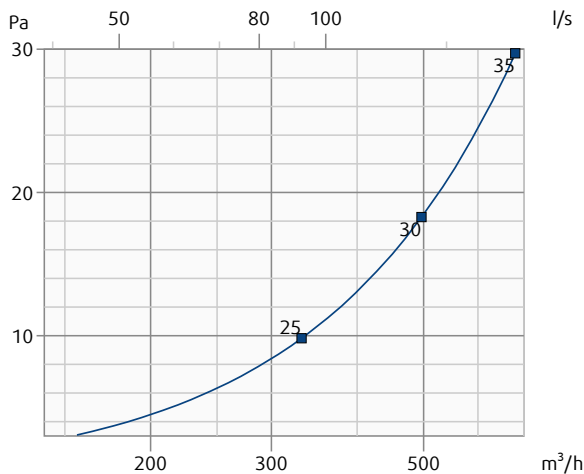

NOVA-PF-525x125-SW

Pressure drop & A-weighted sound power level in dB(A)

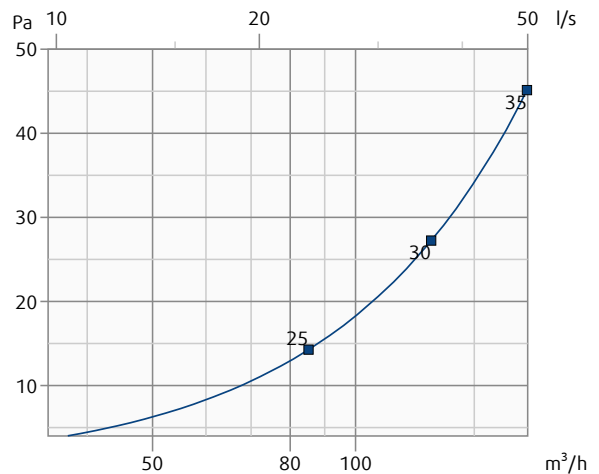

Pressure drop and radiated sound power level dependent on air flow volume.

NOVA-PF-525x225-SW

Pressure drop & A-weighted sound power level in dB(A)

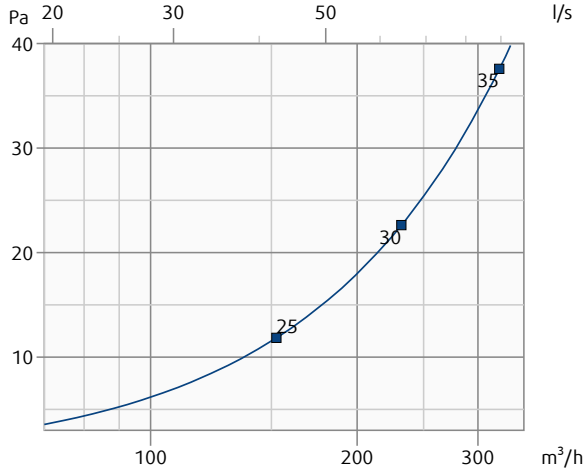

NOVA-PF-525x325-SW

Pressure drop & A-weighted sound power level in dB(A)

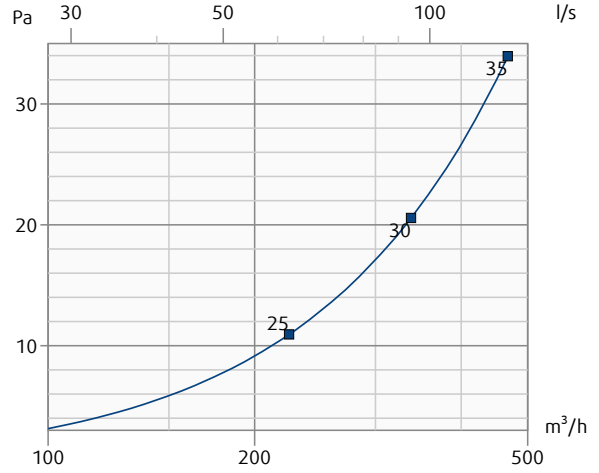

NOVA-PF-525x425-SW

Pressure drop & A-weighted sound power level in dB(A)

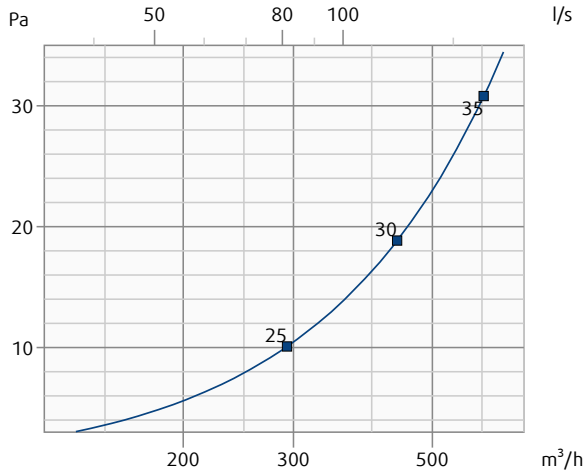

NOVA-PF-525x525-SW

Pressure drop & A-weighted sound power level in dB(A)

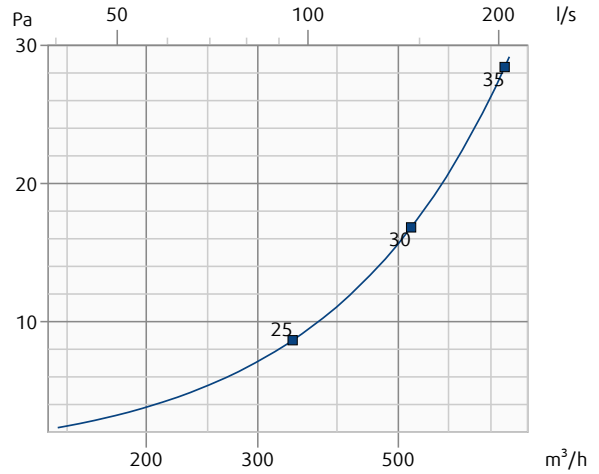

NOVA-PF-600x100-SW

Pressure drop & A-weighted sound power level in dB(A)

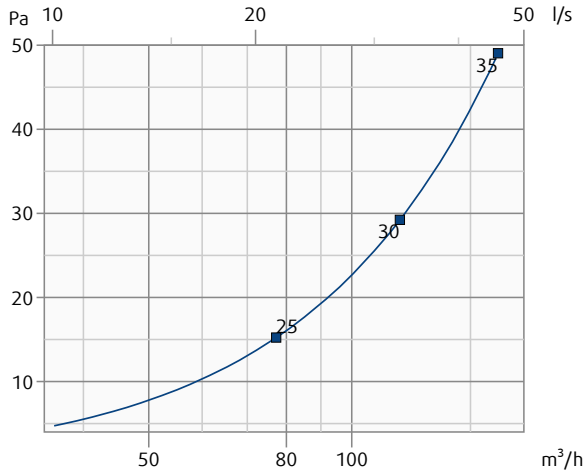

NOVA-PF-600x150-SW

Pressure drop & A-weighted sound power level in dB(A)

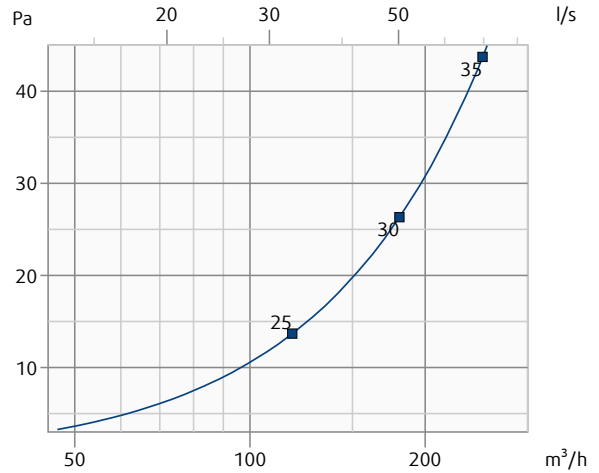

Pressure drop and radiated sound power level dependent on air flow volume.

NOVA-PF-600x200-SW

Pressure drop & A-weighted sound power level in dB(A)

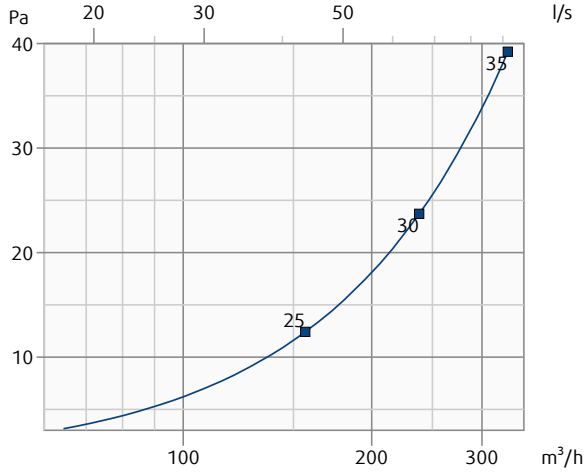

NOVA-PF-600x300-SW

Pressure drop & A-weighted sound power level in dB(A)

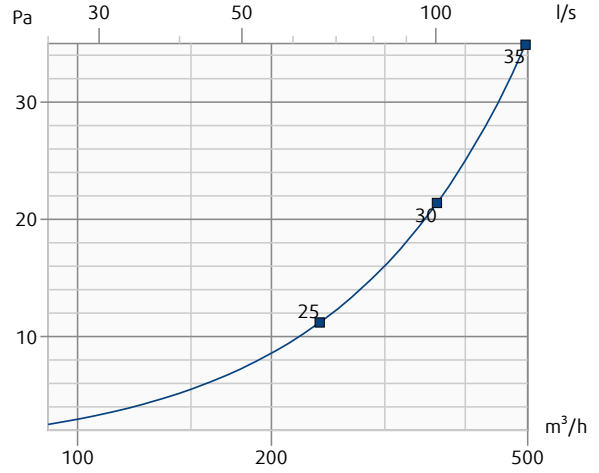

NOVA-PF-600x400-SW

Pressure drop & A-weighted sound power level in dB(A)

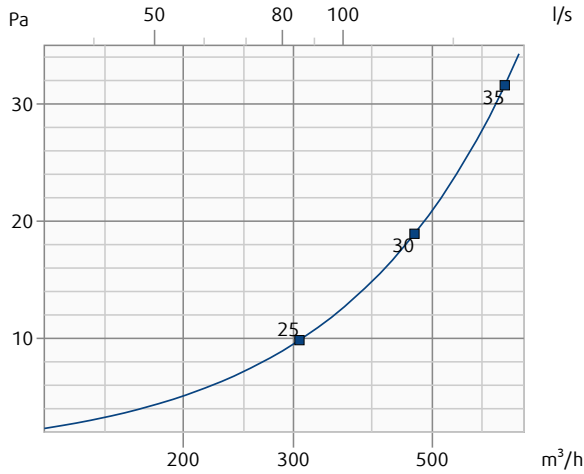

NOVA-PF-600x500-SW

Pressure drop & A-weighted sound power level in dB(A)

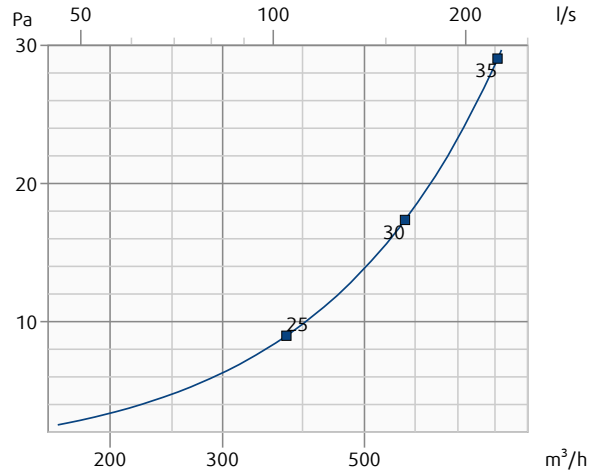

NOVA-PF-625x125-SW

Pressure drop & A-weighted sound power level in dB(A)

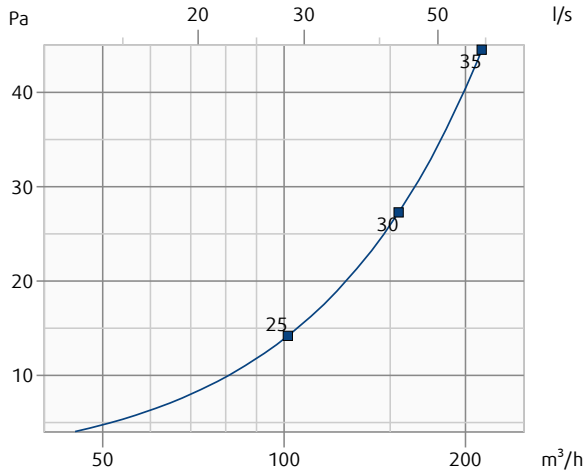

NOVA-PF-625x225-SW

Pressure drop & A-weighted sound power level in dB(A)

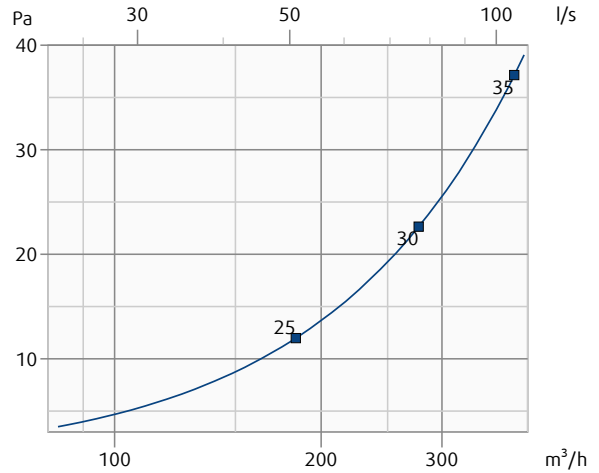

Pressure drop and radiated sound power level dependent on air flow volume.

NOVA-PF-625x325-SW

Pressure drop & A-weighted sound power level in dB(A)

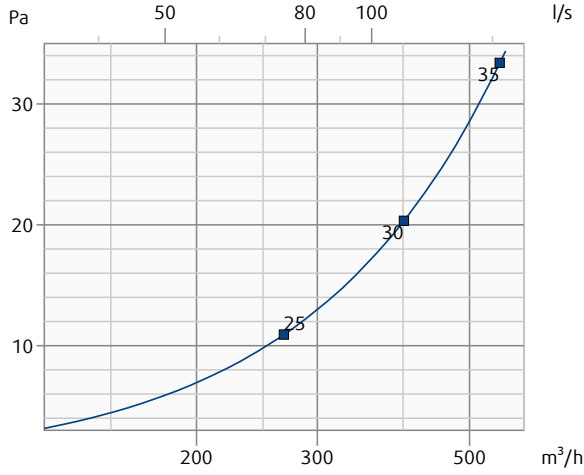

NOVA-PF-625x425-SW

Pressure drop & A-weighted sound power level in dB(A)

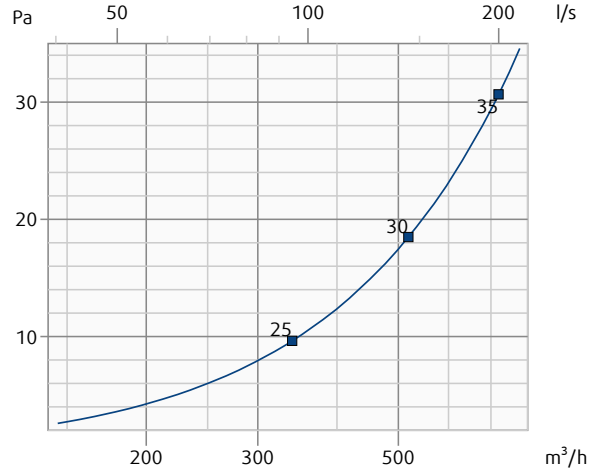

NOVA-PF-625x525-SW

Pressure drop & A-weighted sound power level in dB(A)

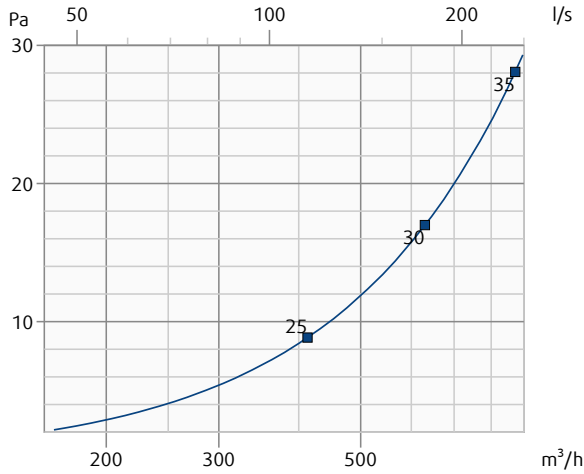

NOVA-PF-800x100-SW

Pressure drop & A-weighted sound power level in dB(A)

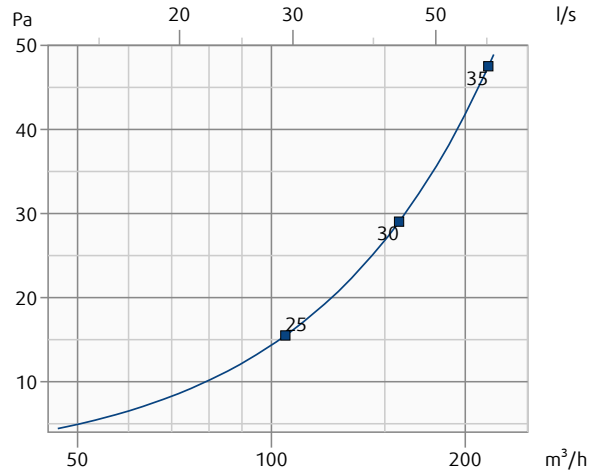

NOVA-PF-800x150-SW

Pressure drop & A-weighted sound power level in dB(A)

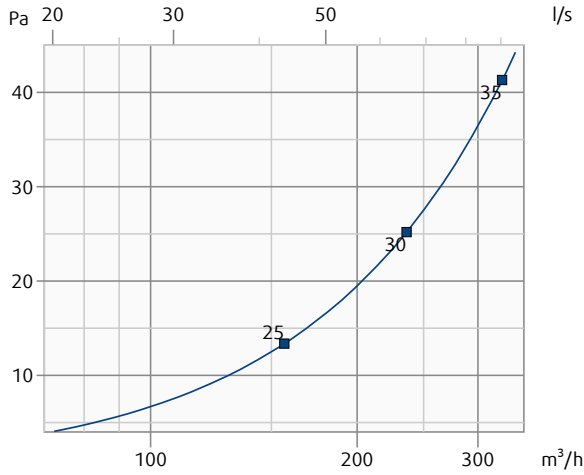

NOVA-PF-800x200-SW

Pressure drop & A-weighted sound power level in dB(A)

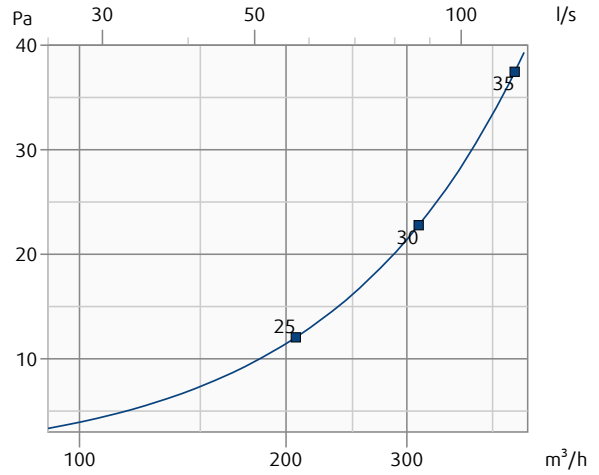

Pressure drop and radiated sound power level dependent on air flow volume.

NOVA-PF-800x300-SW

Pressure drop & A-weighted sound power level in dB(A)

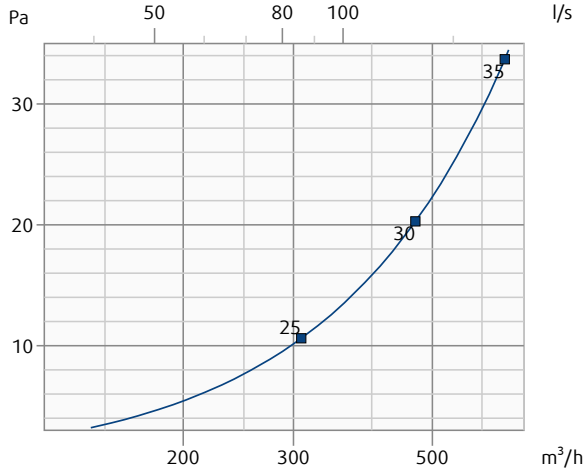

NOVA-PF-800x400-SW

Pressure drop & A-weighted sound power level in dB(A)

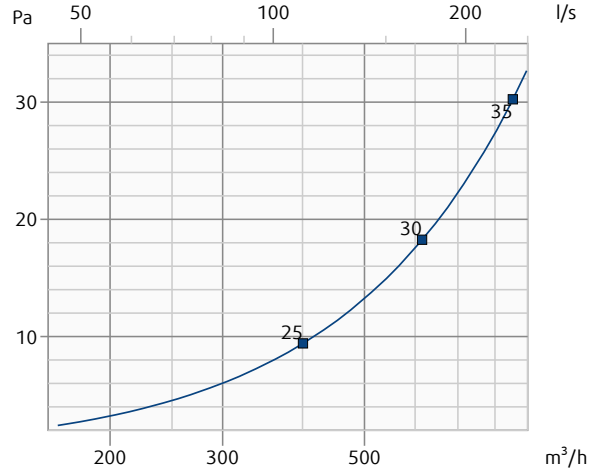

NOVA-PF-800x500-SW

Pressure drop & A-weighted sound power level in dB(A)

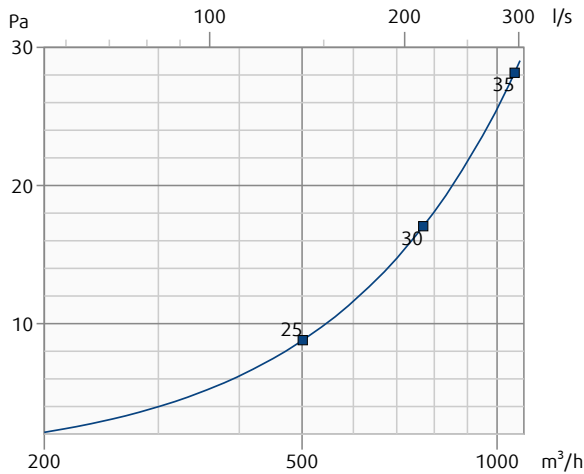

NOVA-PF-825x125-SW

Pressure drop & A-weighted sound power level in dB(A)

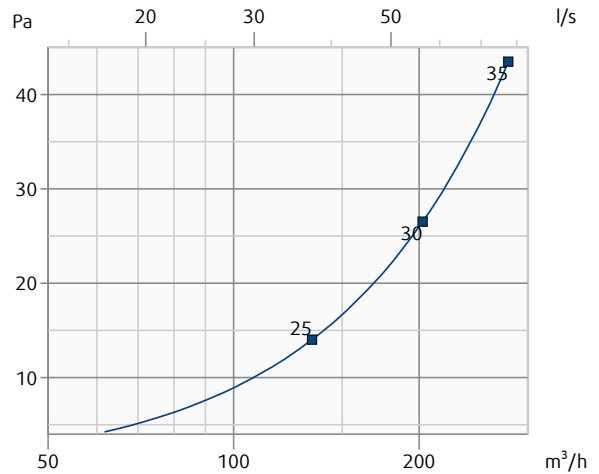

NOVA-PF-825x225-SW

Pressure drop & A-weighted sound power level in dB(A)

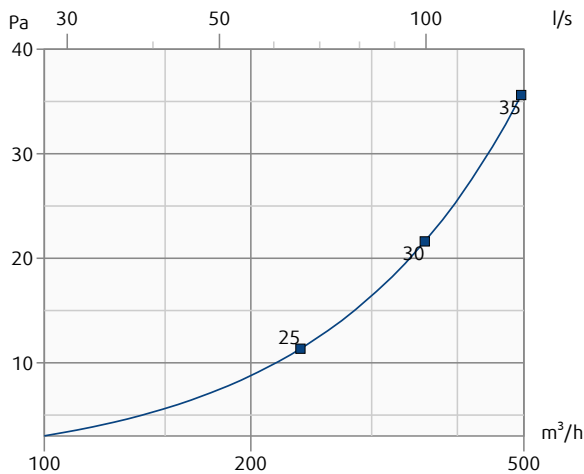

NOVA-PF-825x325-SW

Pressure drop & A-weighted sound power level in dB(A)

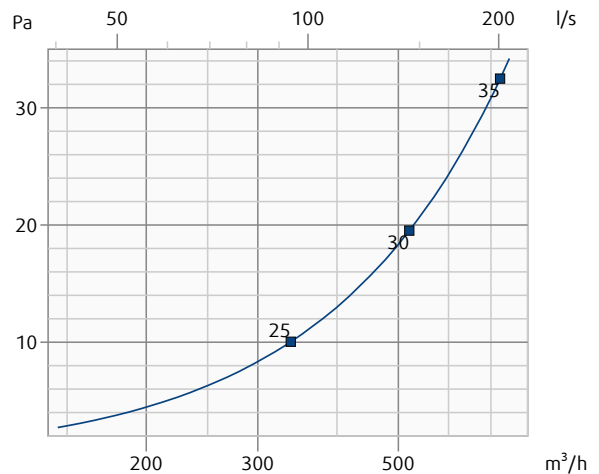

Pressure drop and radiated sound power level dependent on air flow volume.

NOVA-PF-825x425-SW

Pressure drop & A-weighted sound power level in dB(A)

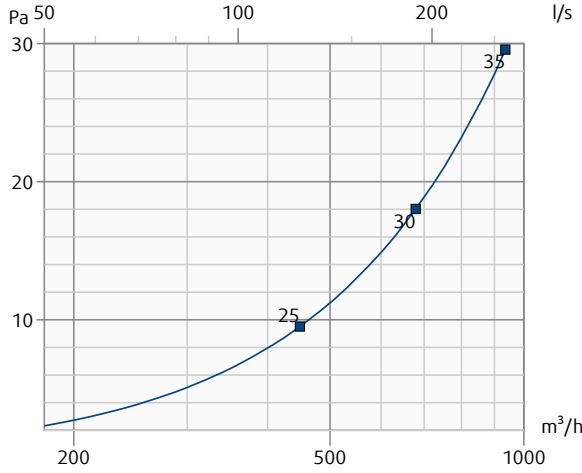

NOVA-PF-825x525-SW

Pressure drop & A-weighted sound power level in dB(A)

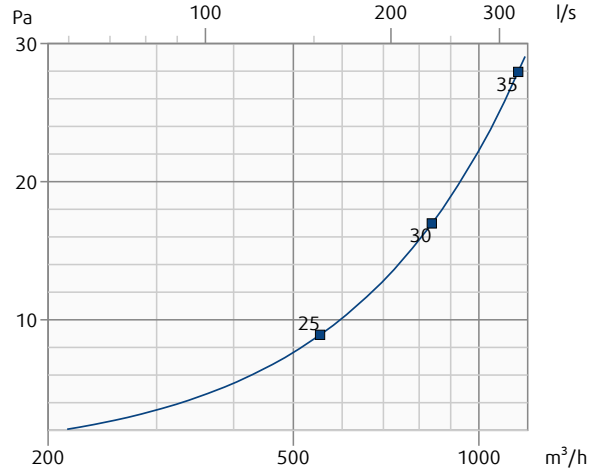

NOVA-PF-1000x100-SW

Pressure drop & A-weighted sound power level in dB(A)

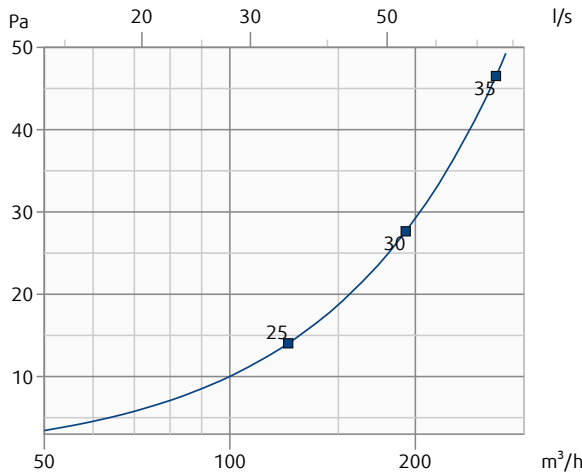

NOVA-PF-1000x150-SW

Pressure drop & A-weighted sound power level in dB(A)

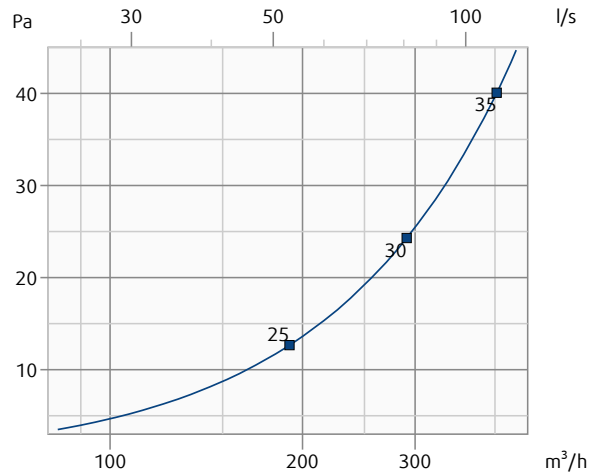

NOVA-PF-1000x200-SW

Pressure drop & A-weighted sound power level in dB(A)

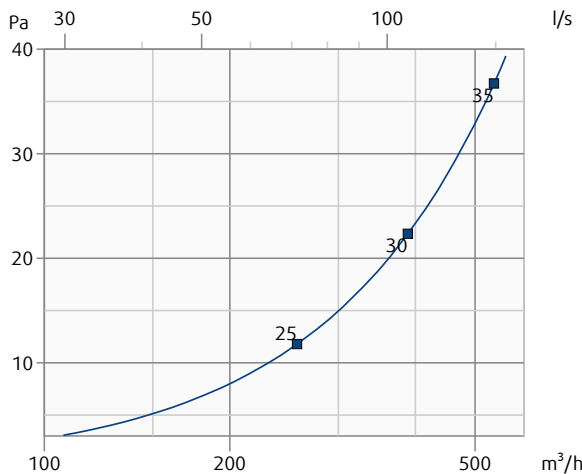

NOVA-PF-1000x300-SW

Pressure drop & A-weighted sound power level in dB(A)

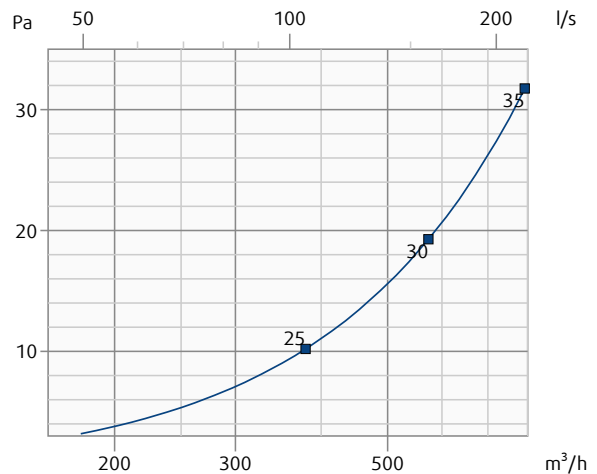

Pressure drop and radiated sound power level dependent on air flow volume.

NOVA-PF-1000x400-SW

Pressure drop & A-weighted sound power level in dB(A)

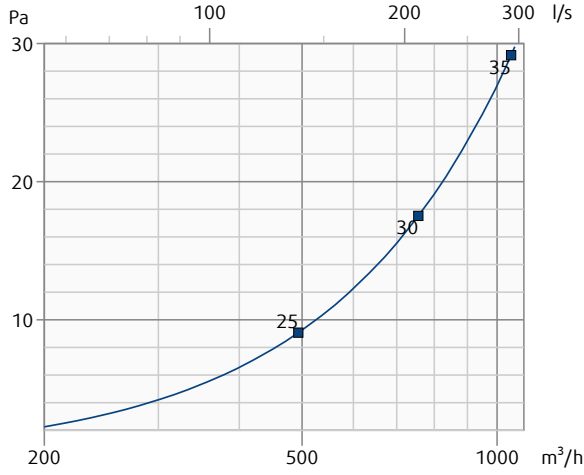

NOVA-PF-1000x500-SW

Pressure drop & A-weighted sound power level in dB(A)

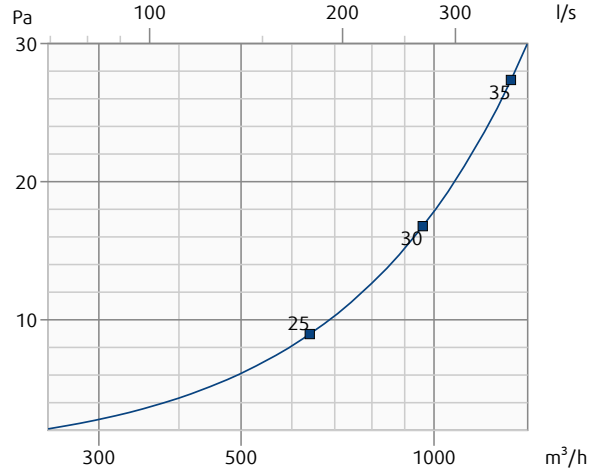

NOVA-PF-1025x125-SW

Pressure drop & A-weighted sound power level in dB(A)

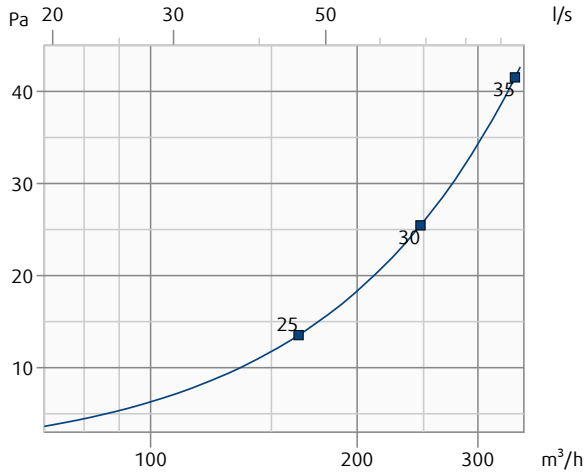

NOVA-PF-1025x225-SW

Pressure drop & A-weighted sound power level in dB(A)

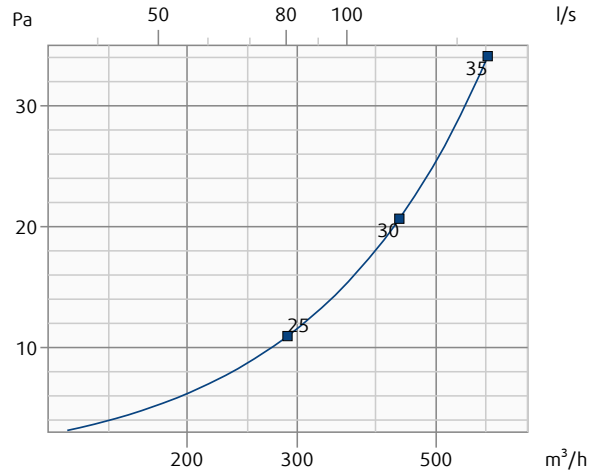

NOVA-PF-1025x325-SW

Pressure drop & A-weighted sound power level in dB(A)

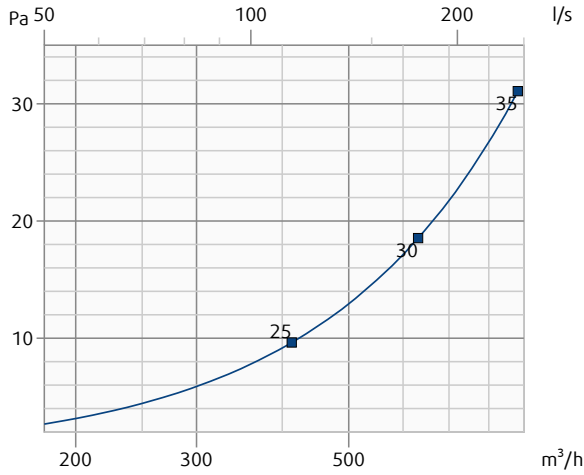

NOVA-PF-1025x425-SW

Pressure drop & A-weighted sound power level in dB(A)

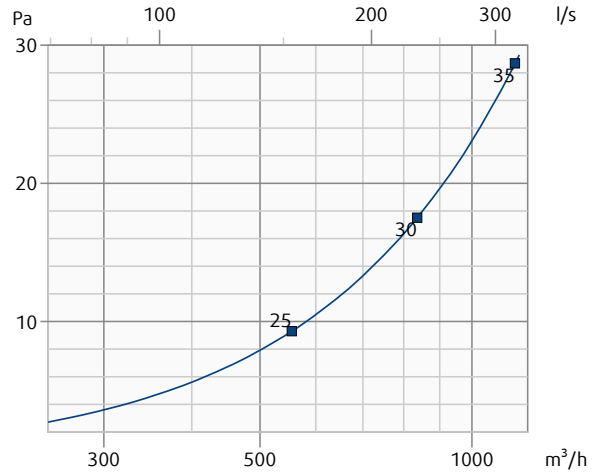

Pressure drop and radiated sound power level dependent on air flow volume.

NOVA-PF-1025x525-SW

Pressure drop & A-weighted sound power level in dB(A)

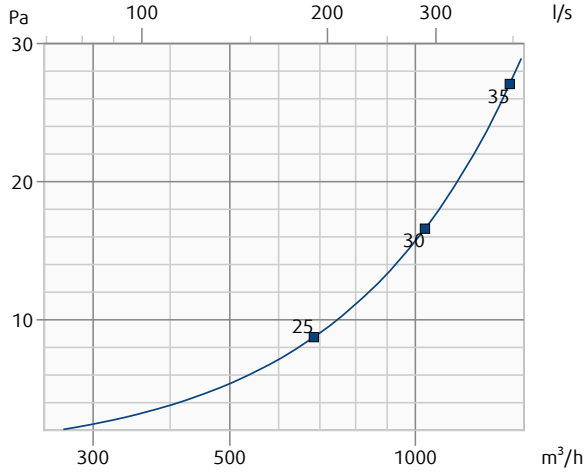

NOVA-PF-1200x100-SW

Pressure drop & A-weighted sound power level in dB(A)

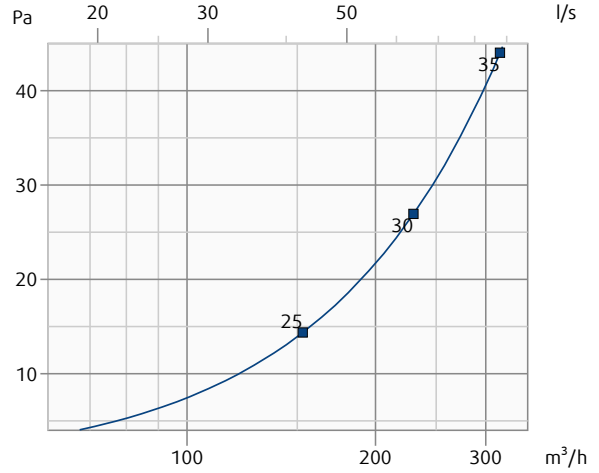

NOVA-PF-1200x150-SW

Pressure drop & A-weighted sound power level in dB(A)

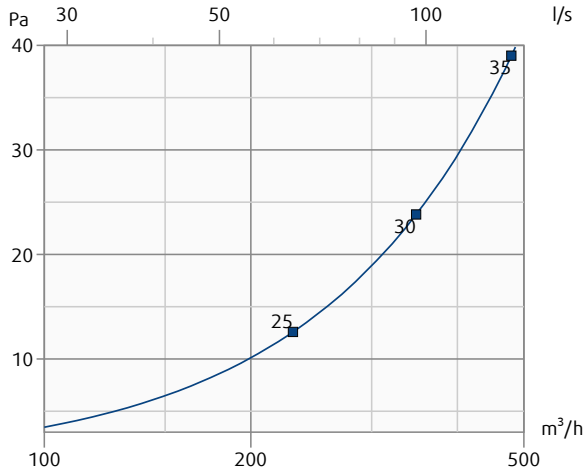

NOVA-PF-1200x200-SW

Pressure drop & A-weighted sound power level in dB(A)

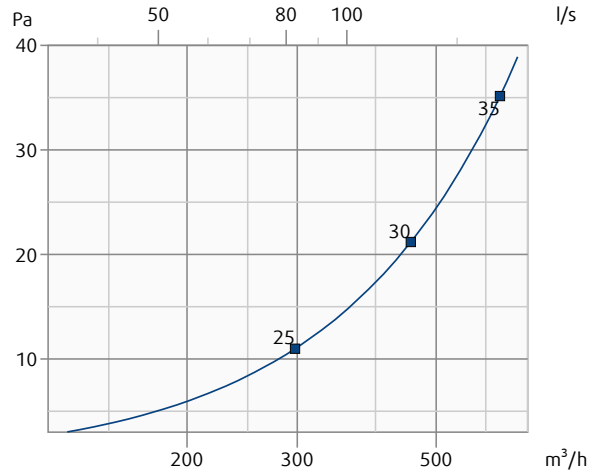

NOVA-PF-1200x300-SW

Pressure drop & A-weighted sound power level in dB(A)

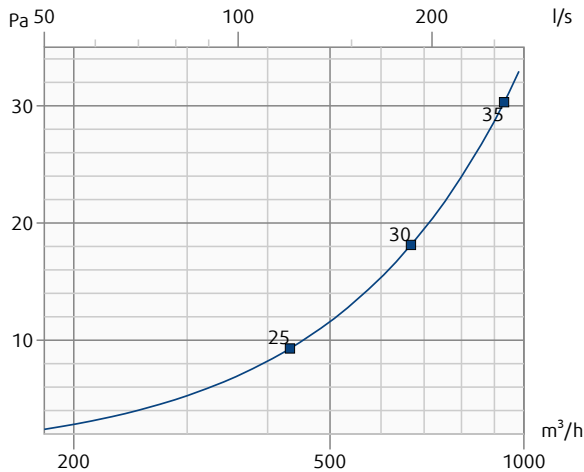

NOVA-PF-1200x400-SW

Pressure drop & A-weighted sound power level in dB(A)

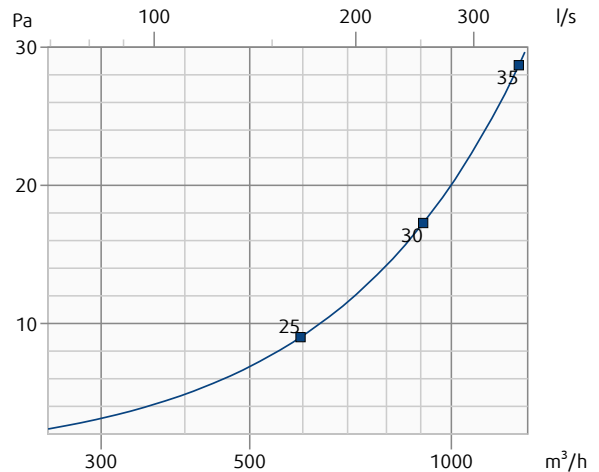

Pressure drop and radiated sound power level dependent on air flow volume.

NOVA-PF-1200x500-SW

Pressure drop & A-weighted sound power level in dB(A)

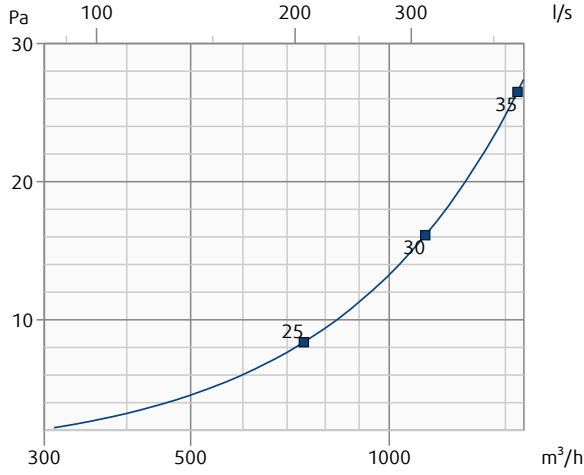

NOVA-PF-1225x125-SW

Pressure drop & A-weighted sound power level in dB(A)

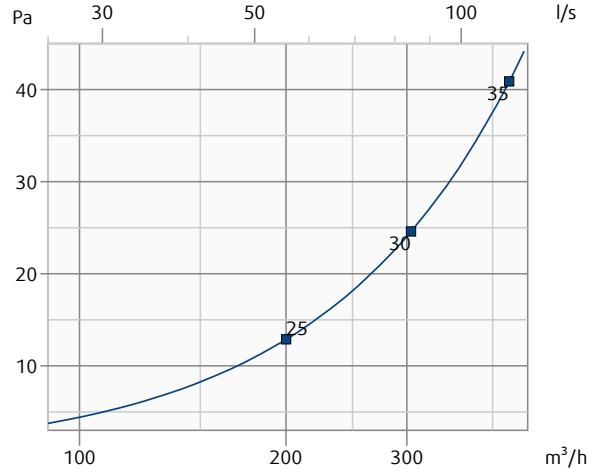

NOVA-PF-1225x225-SW

Pressure drop & A-weighted sound power level in dB(A)

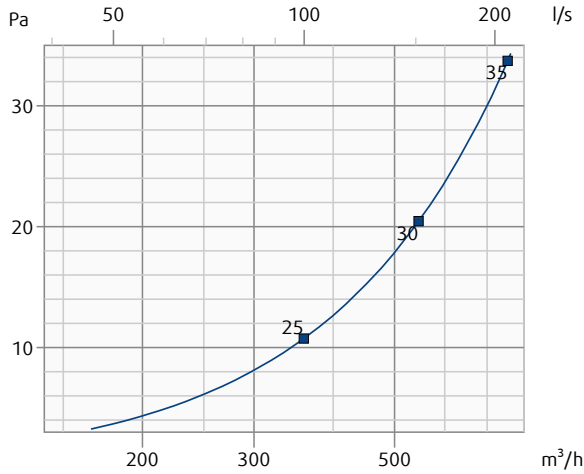

NOVA-PF-1225x325-SW

Pressure drop & A-weighted sound power level in dB(A)

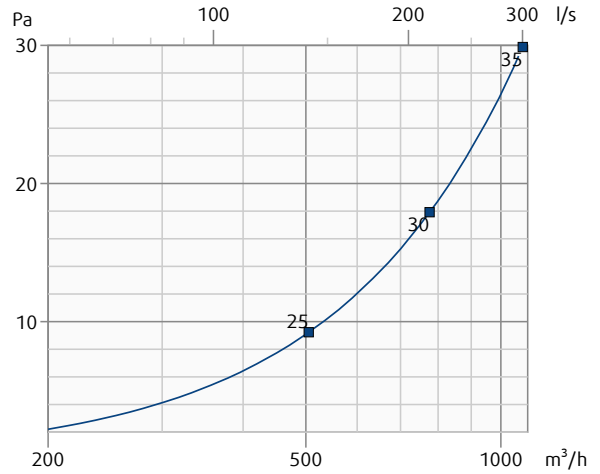

NOVA-PF-1225x425-SW

Pressure drop & A-weighted sound power level in dB(A)

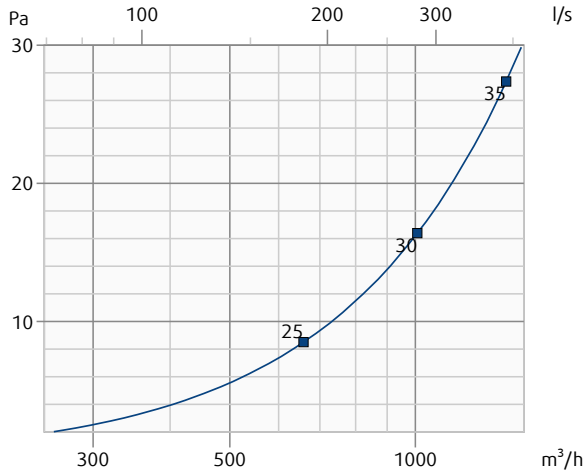

NOVA-PF-1225x525-SW

Pressure drop & A-weighted sound power level in dB(A)

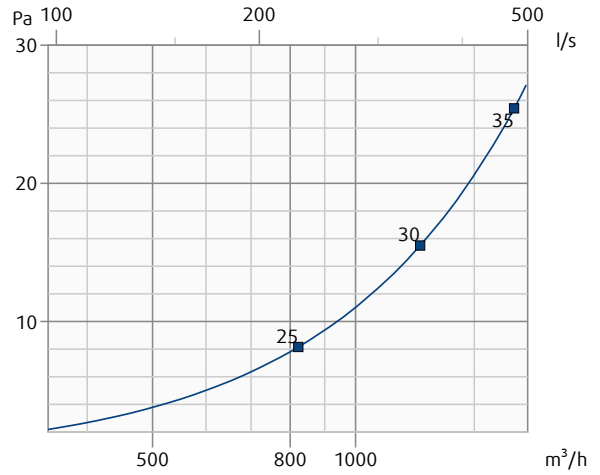

Installation

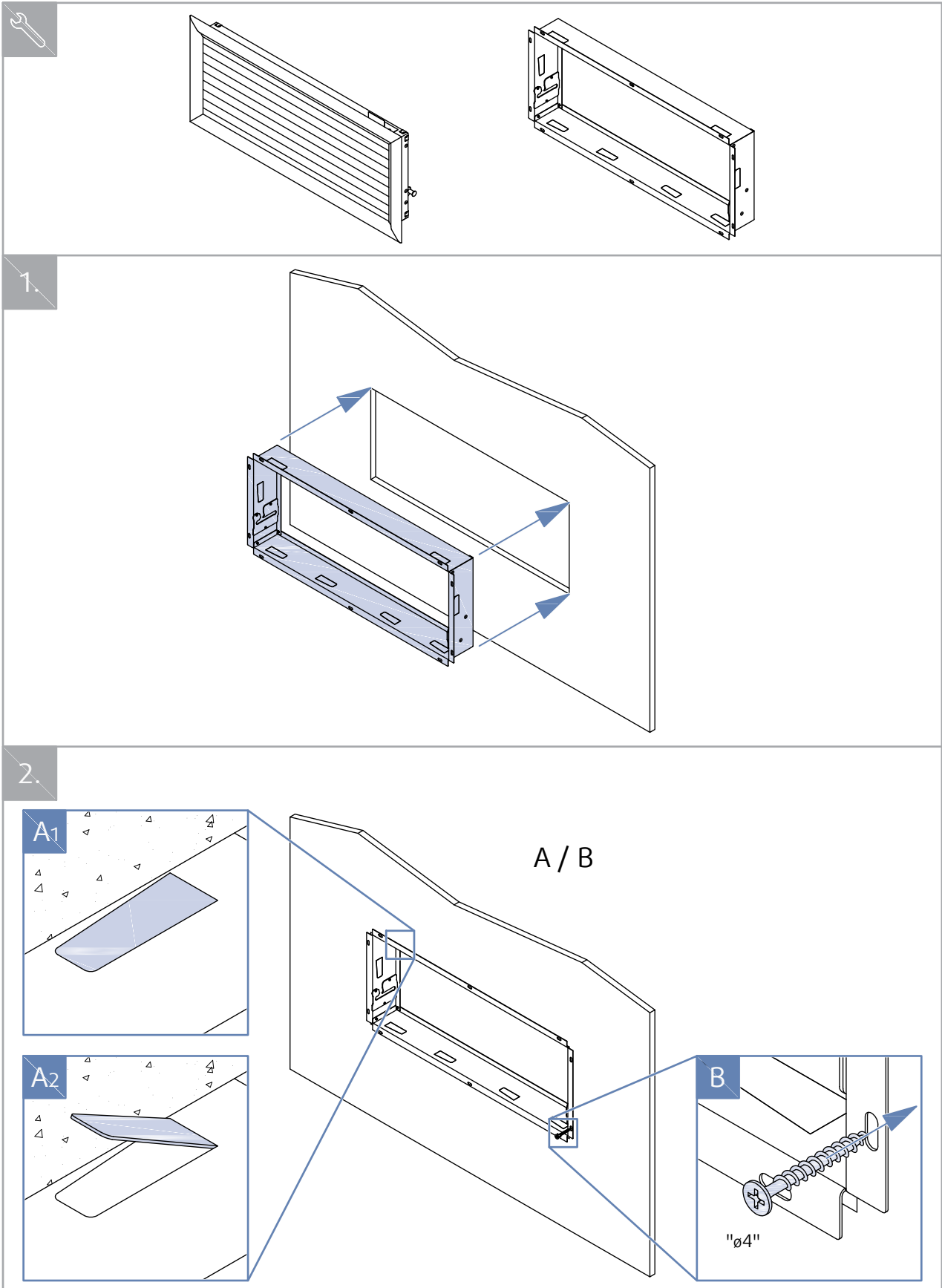

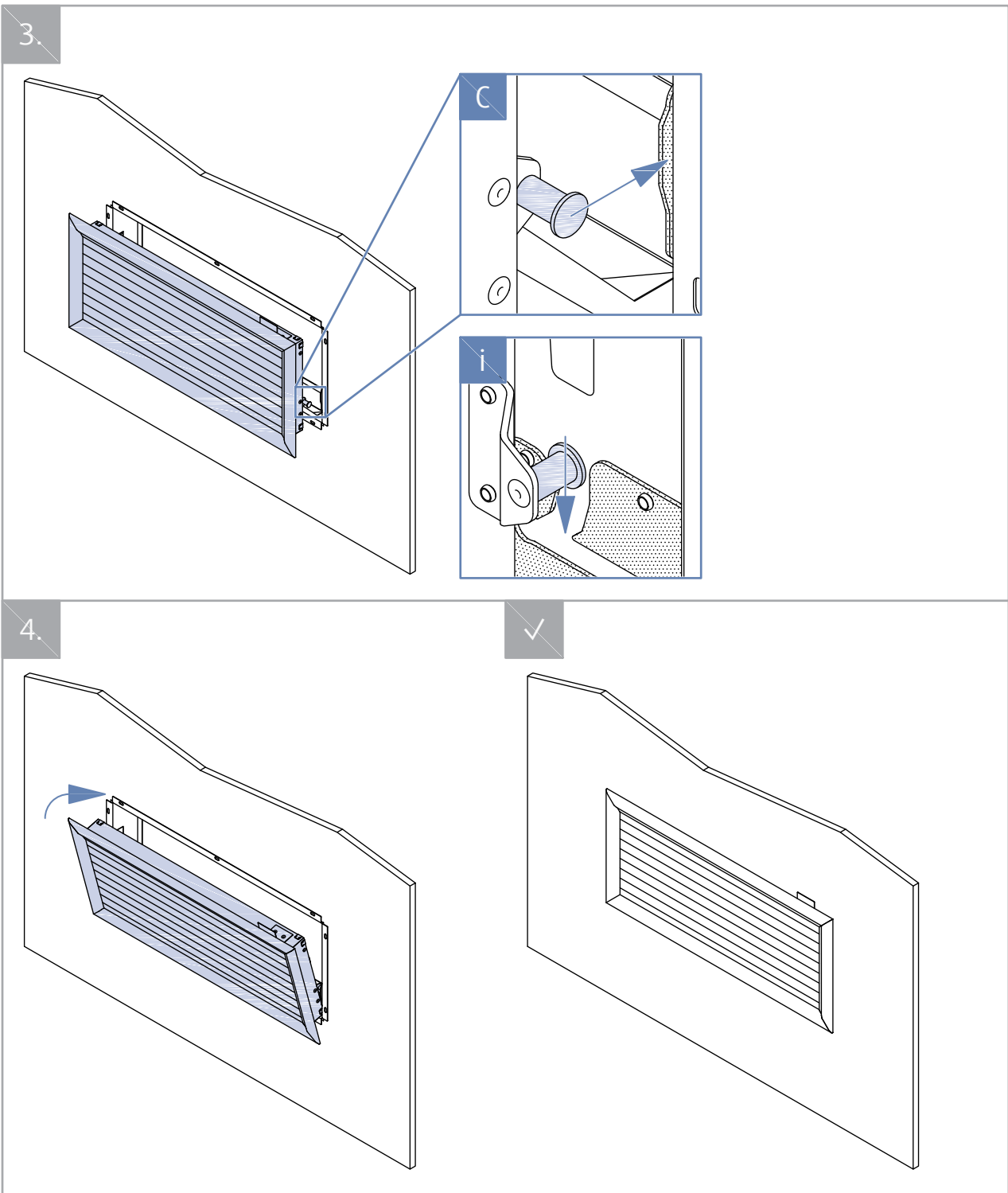

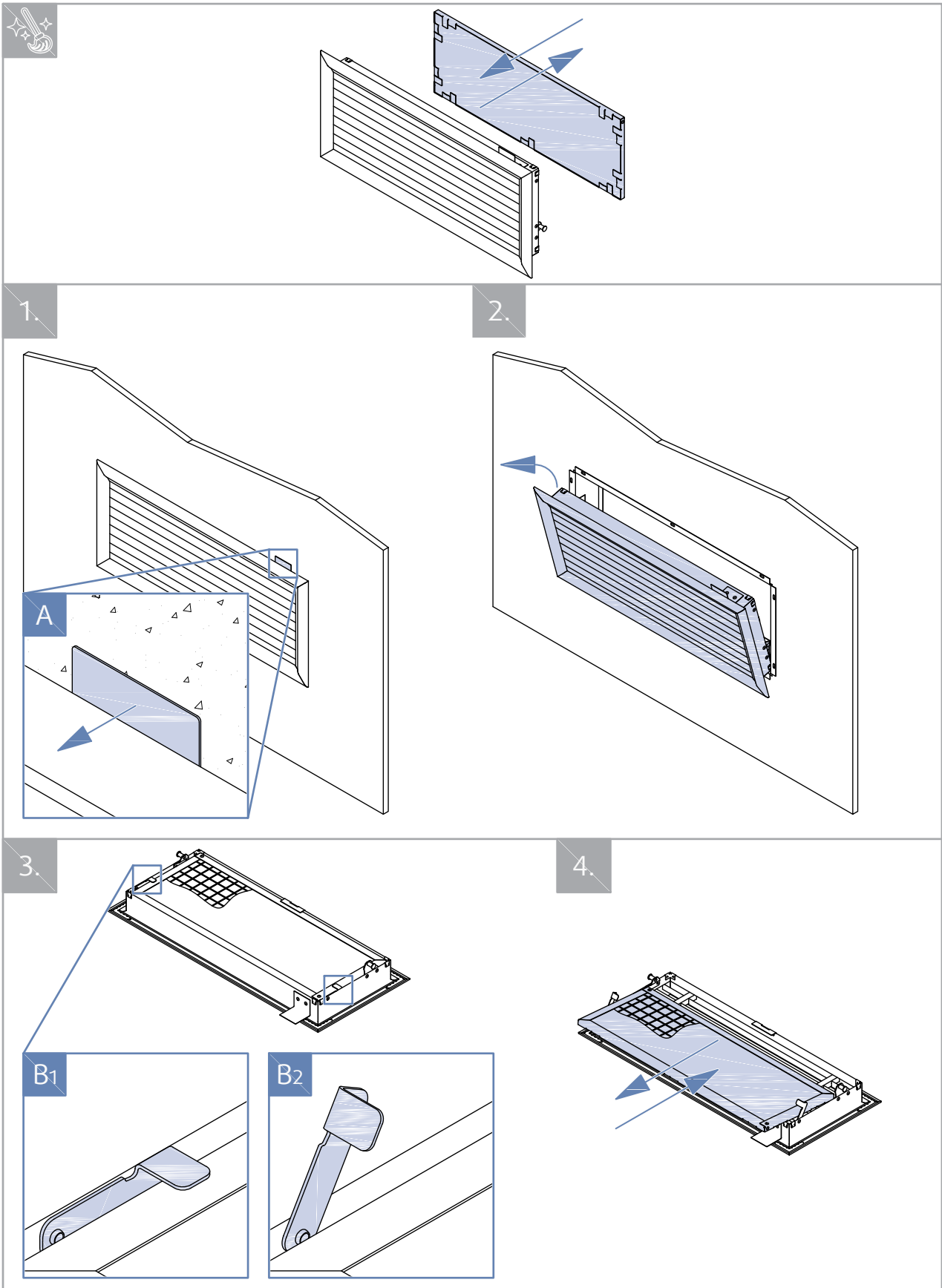

Transport, Storage and Operation

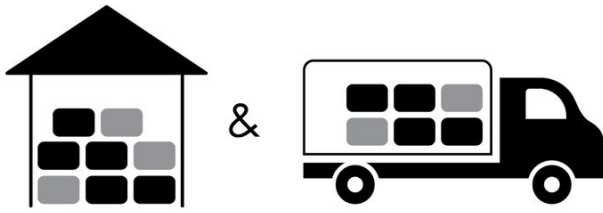

 °C -40°C ... +50°C

 % ≤ 95%



 °C -20°C ... +70°C

 % ≤ 95%

Supplement

Any deviations from the technical specifications contained herein and the terms should be discussed with the manufacturer. We reserve the right to make any changes to the product without prior notice, provided that these changes do not affect the quality of the product and the required parameters.

Current information on all products is available on design.systemair.com.

