

NOVA-H

Perforated Panel Grille

Handbook

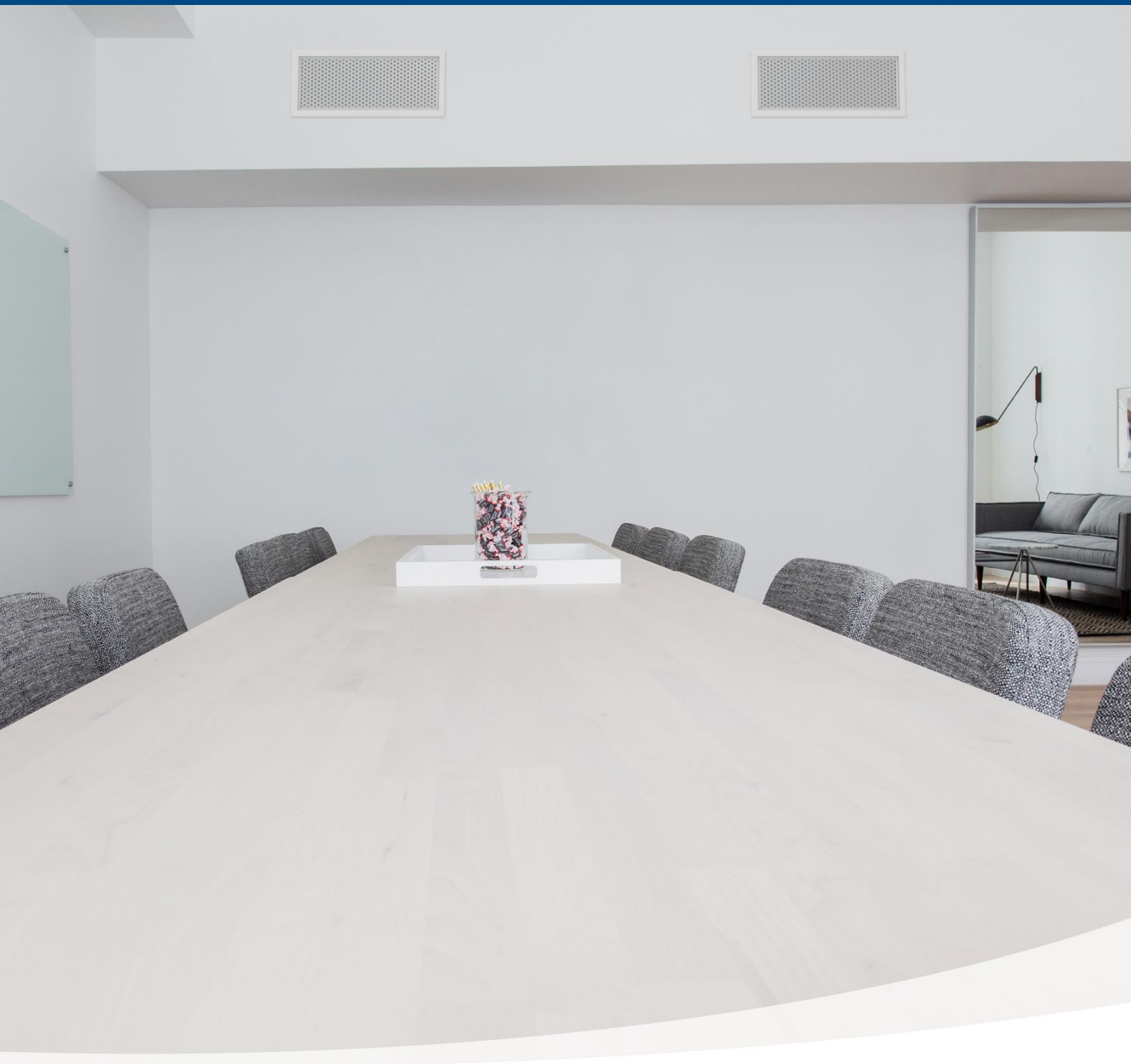

Table of Contents

Description3
Dimensions & Weights5
Ordering Codes7
Accessories8
Quick Selection14
Technical Parameters24
Installation25
Transport, Storage and Operation28
Supplement29



Description

NOVA-H is a diffusion grille with perforated panel. The product is mainly intended for air extract and can be used for air supply as well. The product is installed into rectangular ducts or into walls. For a balanced distribution it is recommended to use the R1-NOVA damper or a plenum box. The field of application is industrial and commercial premises.

Highlights

- Lightweight construction
- Air volume adjustment damper with large authority range available
- Appropriate air extract capacity

List of Accessories

- R1-NOVA: Damper for NOVA
- UR-NOVA: Mounting Frame for NOVA

Design

NOVA-H consists of a frame and a perforated panel. The frame is manufactured from anodized aluminium profiles. The perforated panel is manufactured from galvanized steel sheet. The product is powder painted to RAL9003 (signal white) as standard. Other RAL colours are available upon request.

Product Parts

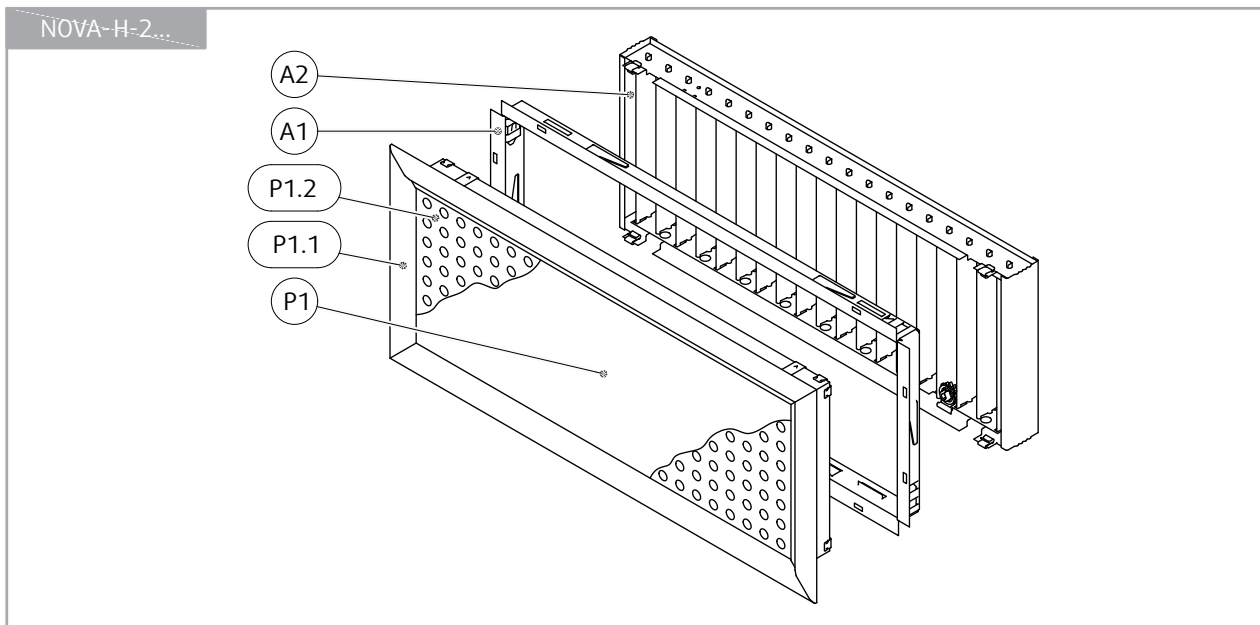

Legend

P1 NOVA-H

P1.1 Grille frame

P1.2 Perforated panel

A1 UR-NOVA (mounting frame for NOVA)

A2 R1-NOVA (damper for NOVA)

Dimensions & Weights

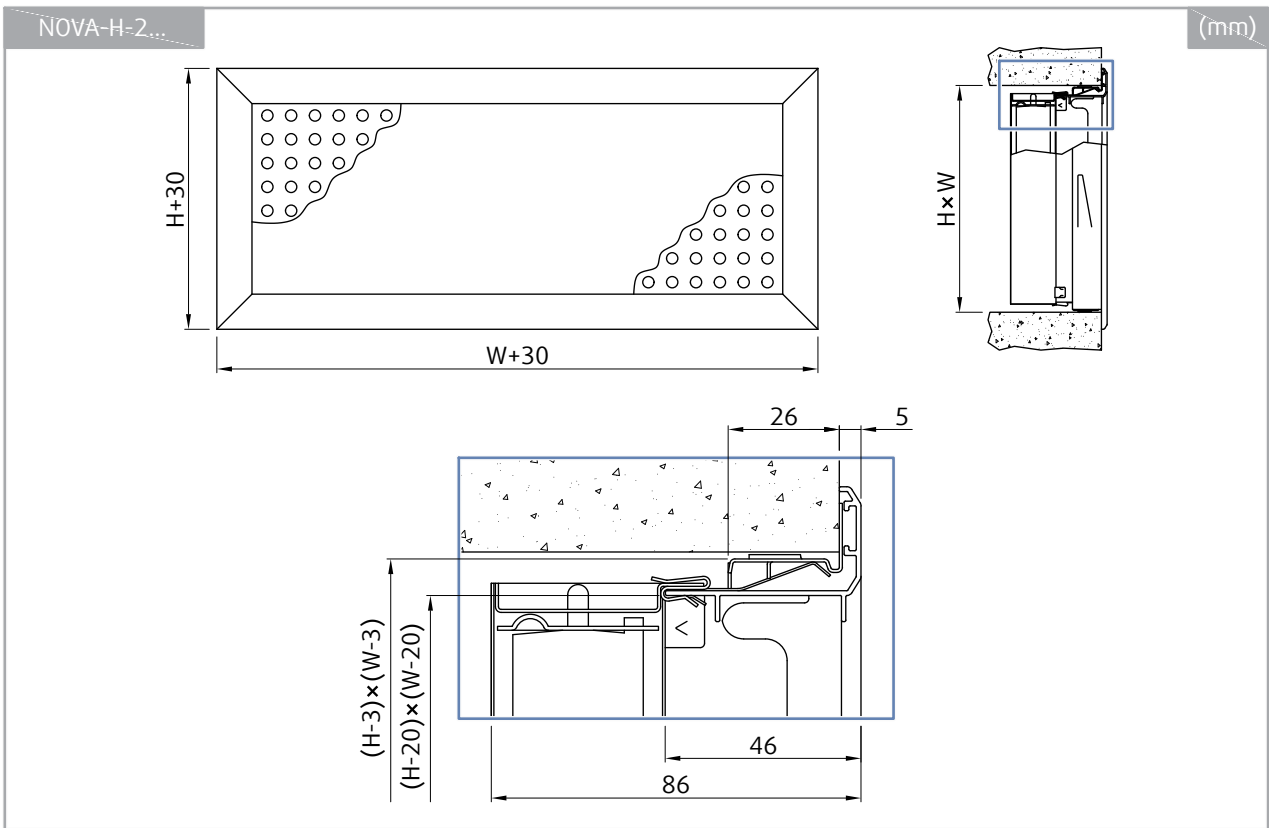
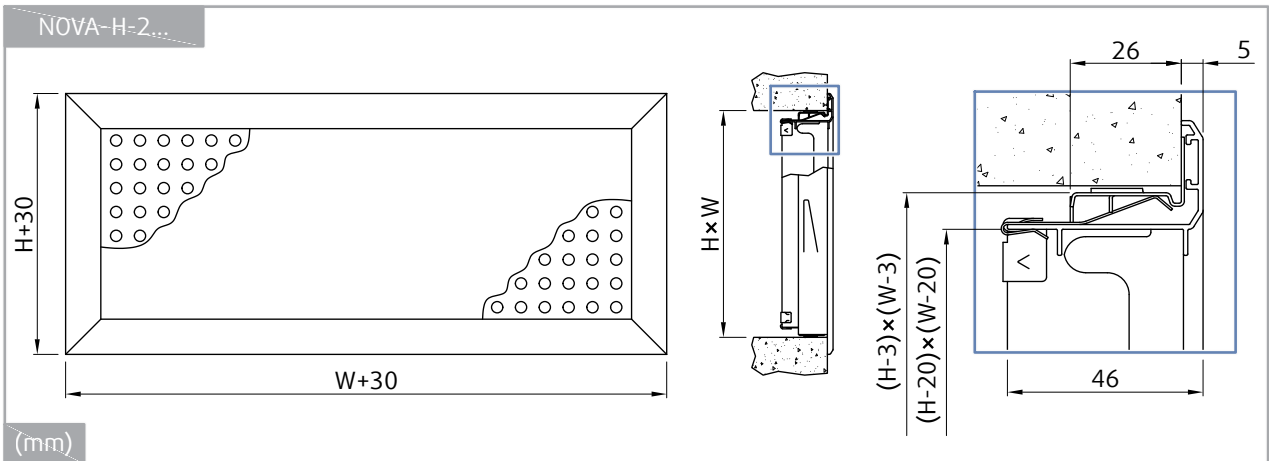

W	H	m	W	H	m
mm		kg	mm		kg
200	100	0,6	225	75	0,5
	150	0,7		125	0,7
	200	0,8		225	0,9
300	100	0,8	325	75	0,7
	150	0,9		125	0,9
	200	1,1		225	1,2
	300	1,4		325	1,5
400	100	0,9	425	75	0,9
	150	1,1		125	1,1
	200	1,3		225	1,4
	300	1,6		325	1,8
	400	2,0		425	2,2
500	100	1,1	525	75	1,1
	150	1,3		125	1,3
	200	1,5		225	1,7
	300	1,9		325	2,1
	400	2,3		425	2,5
	500	2,7		525	2,9
600	100	1,3	625	75	1,2
	150	1,5		125	1,5
	200	1,7		225	1,9
	300	2,2		325	2,3
	400	2,6		425	2,8
	500	3,0		525	3,2
800	100	1,6	825	75	1,6
	150	1,9		125	1,8
	200	2,2		225	2,4
	300	2,7		325	2,9
	400	3,2		425	3,4
	500	3,7		525	3,9
1000	100	2,0	1025	75	1,9
	150	2,3		125	2,2
	200	2,6		225	2,8
	300	3,2		325	3,4
	400	3,8		425	4,0
	500	4,4		525	4,6
	600	5,0			
1200	100	2,3	1225	125	2,5
	150	2,7		225	3,2
	200	3,0		325	3,9
	300	3,7		425	4,6
	400	4,4		525	5,3
	500	5,0		625	6,0
	600	5,7			

$A_V = 46\%$

Ordering Codes

NOVA-H

Fixing

1 Screws

2 Spring clips

Dimensions ¹

W × H

Surface finish ²

SW Signal white (RAL9003, gloss 30%)

RALXXXX Other RAL colour

NOTES:

1. Available dimension combinations are in the dimension table.
2. In case the surface finish is not specified in the ordering code, the product will be delivered powder painted to RAL9003 (signal white) as standard.

Example of Ordering Code

NOVA-H-2-400x200-SW

Perforated panel grille. Mounting with spring clips, intended for a structural opening with dimensions 400 mm × 200 mm. Signal white powder paint RAL9003 surface finish.

Accessories

R1-NOVA

Damper for NOVA

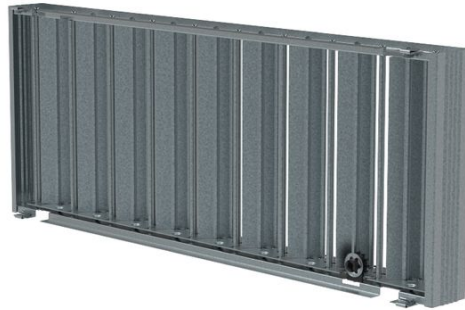

Description

R1-NOVA is a damper for NOVA grilles. The product is intended to balance distribution of air through the entire grille. The product is intended for air supply as well as for air extract. The damper changes the air flow using its regulating wheel.

Design

R1-NOVA is manufactured from galvanized steel sheet. The product consists of a frame, adjustable blades and a regulating wheel. The regulating wheel is operated by a flap tip screwdriver. The blades are opposed and interconnected. The blades angle controls the air flow. The product is provided without any additional surface finish.

Dimension

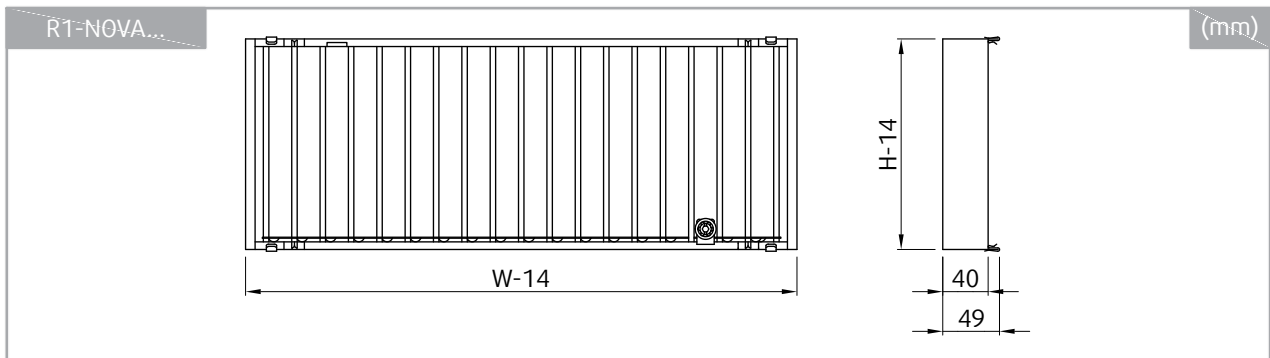

W	H	m
mm		kg
200	100	0,36
	150	0,48
	200	0,61
300	100	0,53
	150	0,71
	200	0,90
	300	1,27
400	100	0,69
	150	0,93
	200	1,18
	300	1,67
	400	2,15
500	100	0,86
	150	1,15
	200	1,47
	300	2,07
	400	2,67
	500	3,29
600	100	1,03
	150	1,38
	200	1,75
	300	2,47
	400	3,19
	500	3,93
800	100	1,40
	150	1,86
	200	2,35
	300	3,30
	400	4,25
	500	5,23
1000	100	1,73
	150	2,30
	200	2,92
	300	4,10
	400	5,28
	500	6,50
1200	100	2,08
	150	2,76
	200	3,49
	300	4,91
	400	6,32
	500	7,78

W	H	m
mm		kg
225	75	0,32
	125	0,47
	225	0,75
325	75	0,46
	125	0,67
	225	1,06
	325	1,46
425	75	0,61
	125	0,87
	225	1,39
	325	1,90
	425	2,42
525	75	0,74
	125	1,07
	225	1,70
	325	2,33
	425	2,96
	525	3,61
625	75	0,88
	125	1,26
	225	2,01
	325	2,76
	425	3,50
	525	4,28
825	75	1,17
	125	1,68
	225	2,65
	325	3,63
	425	4,61
	525	5,62
1025	75	1,45
	125	2,08
	225	3,29
	325	4,50
	425	5,71
	525	6,96
1225	75	1,72
	125	2,47
	225	3,91
	325	5,36
	425	6,80
	525	8,29

Ordering Codes

R1-NOVA

Dimensions

W × H

Example of the Ordering Code

R1-NOVA-400x200

Damper for NOVA, dimensions 400 mm × 200 mm.

UR-NOVA

Mounting Frame for NOVA

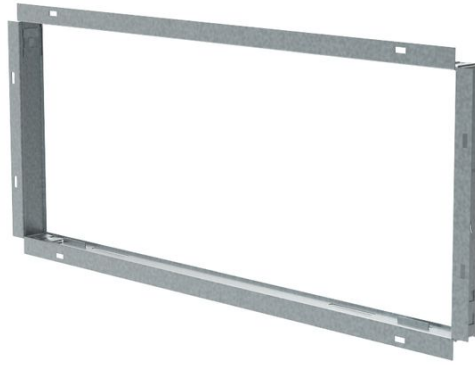
**Description**

UR-NOVA is a mounting frame for NOVA grilles. The product is intended to simplify the installation of a grille. The product is installed into a walls, ceilings or rectangular ducts.

Design

The product is manufactured from galvanized steel sheet. Non-standard version of the product manufactured from stainless steel is available upon request.

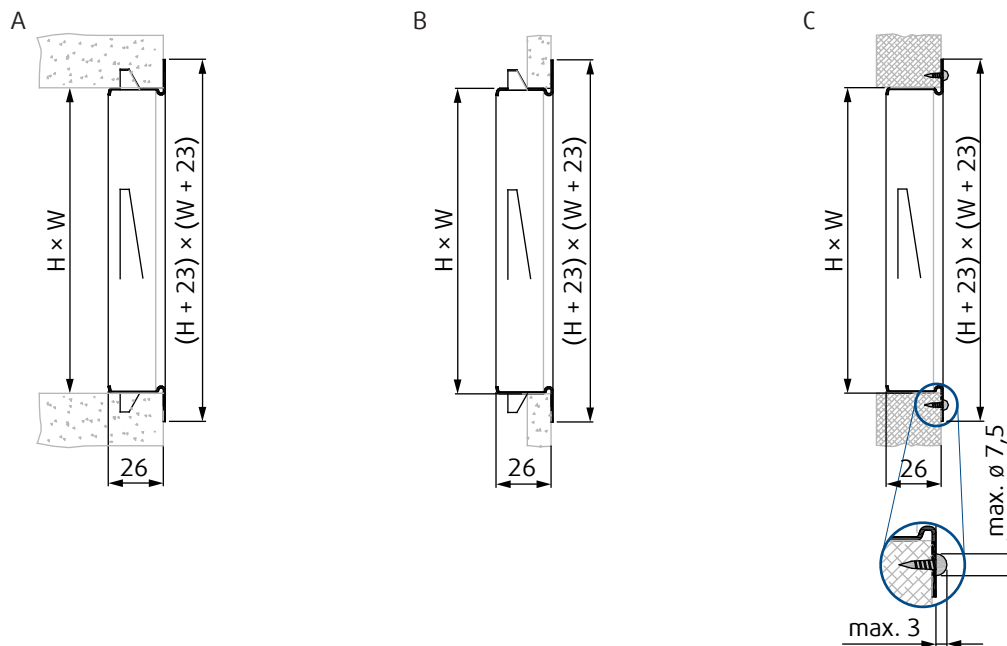
Dimension

A - walling concrete, B - plaster board, C - wood

W	H	m	W	H	m
mm		kg	mm		kg
200	100	0,19	225	75	0,19
	150	0,22		125	0,22
	200	0,26		225	0,29
300	100	0,26	325	75	0,26
	150	0,29		125	0,29
	200	0,33		225	0,36
	300	0,39		325	0,43
400	100	0,33	425	75	0,33
	150	0,36		125	0,36
	200	0,39		225	0,43
	300	0,46		325	0,49
	400	0,53		425	0,56
500	100	0,39	525	75	0,39
	150	0,43		125	0,43
	200	0,46		225	0,49
	300	0,53		325	0,56
	400	0,59		425	0,63
	500	0,66		525	0,69
600	100	0,46	625	75	0,46
	150	0,49		125	0,49
	200	0,53		225	0,56
	300	0,59		325	0,63
	400	0,66		425	0,69
	500	0,73		525	0,76
800	100	0,59	825	75	0,59
	150	0,63		125	0,63
	200	0,66		225	0,69
	300	0,73		325	0,76
	400	0,79		425	0,83
	500	0,86		525	0,90
1000	100	0,73	1025	75	0,73
	150	0,76		125	0,76
	200	0,79		225	0,83
	300	0,86		325	0,90
	400	0,93		425	0,96
	500	1,00		525	1,03
1200	100	0,86	1225	75	0,86
	150	0,90		125	0,90
	200	0,93		225	0,96
	300	1,00		325	1,03
	400	1,06		425	1,10
	500	1,13		525	1,16

Ordering Codes

UR-NOVA

Dimensions

W × H

Example of the Ordering Code

UR-NOVA-400x200

Mounting frame for NOVA, dimensions 400 mm × 200 mm.

Quick Selection

Air flow volume q_v at different A-weighted sound power levels L_{WA}

Item	25 dB(A)		30 dB(A)		35 dB(A)	
	m ³ /h	l/s	m ³ /h	l/s	m ³ /h	l/s
NOVA-H-1-200x100-SW	66	18	85	24	106	29
NOVA-H-1-200x100-SW + R1-NOVA-200x100	32	9	43	12	56	15
NOVA-H-1-200x150-SW	103	29	131	36	163	45
NOVA-H-1-200x150-SW + R1-NOVA-200x150	50	14	66	18	86	24
NOVA-H-1-200x200-SW	142	39	179	50	222	62
NOVA-H-1-200x200-SW + R1-NOVA-200x200	69	19	91	25	117	32
NOVA-H-1-225x75-SW	780	217	780	217	780	217
NOVA-H-1-225x75-SW + R1-NOVA-225x75	735	204	735	204	735	204
NOVA-H-1-225x125-SW	96	27	122	34	153	42
NOVA-H-1-225x125-SW + R1-NOVA-225x125	47	13	62	17	80	22
NOVA-H-1-225x225-SW	184	51	232	65	288	80
NOVA-H-1-225x225-SW + R1-NOVA-225x225	90	25	118	33	151	42
NOVA-H-1-300x100-SW	103	29	131	36	163	45
NOVA-H-1-300x100-SW + R1-NOVA-300x100	50	14	66	18	86	24
NOVA-H-1-300x150-SW	161	45	203	56	252	70
NOVA-H-1-300x150-SW + R1-NOVA-300x150	79	22	104	29	132	37
NOVA-H-1-300x200-SW	222	62	278	77	344	96
NOVA-H-1-300x200-SW + R1-NOVA-300x200	109	30	141	39	181	50
NOVA-H-1-300x300-SW	346	96	434	121	535	149
NOVA-H-1-300x300-SW + R1-NOVA-300x300	170	47	220	61	281	78
NOVA-H-1-325x75-SW	862	239	862	239	862	239
NOVA-H-1-325x75-SW + R1-NOVA-325x75	765	212	765	212	765	212
NOVA-H-1-325x125-SW	144	40	183	51	227	63
NOVA-H-1-325x125-SW + R1-NOVA-325x125	71	20	93	26	119	33
NOVA-H-1-325x225-SW	275	76	346	96	428	119
NOVA-H-1-325x225-SW + R1-NOVA-325x225	135	38	176	49	225	62
NOVA-H-1-325x325-SW	413	115	517	144	636	177
NOVA-H-1-325x325-SW + R1-NOVA-325x325	203	56	263	73	334	93
NOVA-H-1-400x100-SW	141	39	179	50	224	62
NOVA-H-1-400x100-SW + R1-NOVA-400x100	69	19	91	25	117	33
NOVA-H-1-400x150-SW	222	62	279	78	346	96
NOVA-H-1-400x150-SW + R1-NOVA-400x150	109	30	142	39	181	50
NOVA-H-1-400x200-SW	304	85	381	106	469	130
NOVA-H-1-400x200-SW + R1-NOVA-400x200	150	42	194	54	246	68
NOVA-H-1-400x300-SW	477	133	592	164	726	202
NOVA-H-1-400x300-SW + R1-NOVA-400x300	235	65	301	84	380	106

Item	25 dB(A)		30 dB(A)		35 dB(A)	
	m ³ /h	l/s	m ³ /h	l/s	m ³ /h	l/s
NOVA-H-1-400x400-SW	656	182	809	225	988	275
NOVA-H-1-400x400-SW + R1-NOVA-400x400	323	90	412	114	518	144
NOVA-H-1-425x75-SW	900	250	900	250	900	250
NOVA-H-1-425x75-SW + R1-NOVA-425x75	795	221	795	221	795	221
NOVA-H-1-425x125-SW	195	54	244	68	302	84
NOVA-H-1-425x125-SW + R1-NOVA-425x125	96	27	124	35	159	44
NOVA-H-1-425x225-SW	369	103	464	129	572	159
NOVA-H-1-425x225-SW + R1-NOVA-425x225	181	50	236	66	301	84
NOVA-H-1-425x325-SW	557	155	691	192	845	235
NOVA-H-1-425x325-SW + R1-NOVA-425x325	274	76	351	97	443	123
NOVA-H-1-425x425-SW	749	208	928	258	1133	315
NOVA-H-1-425x425-SW + R1-NOVA-425x425	368	102	472	131	594	165
NOVA-H-1-500x100-SW	182	50	229	64	284	79
NOVA-H-1-500x100-SW + R1-NOVA-500x100	90	25	117	32	149	41
NOVA-H-1-500x150-SW	283	79	356	99	440	122
NOVA-H-1-500x150-SW + R1-NOVA-500x150	139	39	181	50	231	64
NOVA-H-1-500x200-SW	390	108	487	135	600	167
NOVA-H-1-500x200-SW + R1-NOVA-500x200	192	53	248	69	315	87
NOVA-H-1-500x300-SW	611	170	755	210	922	256
NOVA-H-1-500x300-SW + R1-NOVA-500x300	300	83	383	107	484	134
NOVA-H-1-500x400-SW	838	233	1034	287	1258	350
NOVA-H-1-500x400-SW + R1-NOVA-500x400	412	114	526	146	660	183
NOVA-H-1-500x500-SW	1069	297	1321	367	1605	446
NOVA-H-1-500x500-SW + R1-NOVA-500x500	525	146	672	187	842	234
NOVA-H-1-525x75-SW	900	250	900	250	900	250
NOVA-H-1-525x75-SW + R1-NOVA-525x75	825	229	825	229	825	229
NOVA-H-1-525x125-SW	244	68	308	86	381	106
NOVA-H-1-525x125-SW + R1-NOVA-525x125	120	33	157	44	200	56
NOVA-H-1-525x225-SW	468	130	585	162	718	200
NOVA-H-1-525x225-SW + R1-NOVA-525x225	230	64	298	83	377	105
NOVA-H-1-525x325-SW	701	195	871	242	1066	296
NOVA-H-1-525x325-SW + R1-NOVA-525x325	344	96	443	123	559	155
NOVA-H-1-525x425-SW	947	263	1164	323	1414	393
NOVA-H-1-525x425-SW + R1-NOVA-525x425	465	129	592	164	741	206
NOVA-H-1-525x525-SW	1194	332	1467	407	1779	494
NOVA-H-1-525x525-SW + R1-NOVA-525x525	587	163	746	207	934	259
NOVA-H-1-600x100-SW	222	62	279	78	346	96
NOVA-H-1-600x100-SW + R1-NOVA-600x100	109	30	142	39	181	50
NOVA-H-1-600x150-SW	345	96	434	121	536	149

Item	25 dB(A)		30 dB(A)		35 dB(A)	
	m ³ /h	l/s	m ³ /h	l/s	m ³ /h	l/s
NOVA-H-1-600x150-SW + R1-NOVA-600x150	170	47	221	61	282	78
NOVA-H-1-600x200-SW	476	132	595	165	730	203
NOVA-H-1-600x200-SW + R1-NOVA-600x200	234	65	303	84	383	106
NOVA-H-1-600x300-SW	747	208	920	256	1122	312
NOVA-H-1-600x300-SW + R1-NOVA-600x300	367	102	468	130	589	163
NOVA-H-1-600x400-SW	1026	285	1260	350	1530	425
NOVA-H-1-600x400-SW + R1-NOVA-600x400	504	140	640	178	803	223
NOVA-H-1-600x500-SW	1312	364	1609	447	1947	541
NOVA-H-1-600x500-SW + R1-NOVA-600x500	645	179	818	227	1022	284
NOVA-H-1-625x75-SW	900	250	900	250	900	250
NOVA-H-1-625x75-SW + R1-NOVA-625x75	862	239	862	239	862	239
NOVA-H-1-625x125-SW	296	82	372	103	460	128
NOVA-H-1-625x125-SW + R1-NOVA-625x125	146	40	190	53	241	67
NOVA-H-1-625x225-SW	567	158	706	196	866	241
NOVA-H-1-625x225-SW + R1-NOVA-625x225	279	77	359	100	455	126
NOVA-H-1-625x325-SW	852	237	1052	292	1281	356
NOVA-H-1-625x325-SW + R1-NOVA-625x325	419	116	535	148	672	187
NOVA-H-1-625x425-SW	1152	320	1412	392	1712	476
NOVA-H-1-625x425-SW + R1-NOVA-625x425	567	157	719	200	898	250
NOVA-H-1-625x525-SW	1452	403	1779	494	2153	598
NOVA-H-1-625x525-SW + R1-NOVA-625x525	714	198	905	251	1130	314
NOVA-H-1-800x100-SW	305	85	382	106	471	131
NOVA-H-1-800x100-SW + R1-NOVA-800x100	150	42	194	54	248	69
NOVA-H-1-800x150-SW	476	132	593	165	727	202
NOVA-H-1-800x150-SW + R1-NOVA-800x150	234	65	302	84	382	106
NOVA-H-1-800x200-SW	656	182	813	226	995	276
NOVA-H-1-800x200-SW + R1-NOVA-800x200	323	90	414	115	522	145
NOVA-H-1-800x300-SW	1025	285	1261	350	1531	425
NOVA-H-1-800x300-SW + R1-NOVA-800x300	504	140	641	178	803	223
NOVA-H-1-800x400-SW	1406	391	1732	481	2098	583
NOVA-H-1-800x400-SW + R1-NOVA-800x400	691	192	881	245	1101	306
NOVA-H-1-800x500-SW	1798	500	2204	612	2662	739
NOVA-H-1-800x500-SW + R1-NOVA-800x500	883	245	1121	311	1397	388
NOVA-H-1-825x75-SW	900	250	900	250	900	250
NOVA-H-1-825x75-SW + R1-NOVA-825x75	900	250	900	250	900	250
NOVA-H-1-825x125-SW	402	112	504	140	620	172
NOVA-H-1-825x125-SW + R1-NOVA-825x125	197	55	256	71	326	90
NOVA-H-1-825x225-SW	773	215	952	265	1160	322
NOVA-H-1-825x225-SW + R1-NOVA-825x225	380	105	484	134	608	169

Item	25 dB(A)		30 dB(A)		35 dB(A)	
	m ³ /h	l/s	m ³ /h	l/s	m ³ /h	l/s
NOVA-H-1-825x325-SW	1157	321	1427	396	1733	481
NOVA-H-1-825x325-SW + R1-NOVA-825x325	568	158	726	202	909	253
NOVA-H-1-825x425-SW	1556	432	1911	531	2310	642
NOVA-H-1-825x425-SW + R1-NOVA-825x425	765	213	972	270	1212	337
NOVA-H-1-825x525-SW	1961	545	2406	668	2903	806
NOVA-H-1-825x525-SW + R1-NOVA-825x525	963	268	1223	340	1523	423
NOVA-H-1-1000x100-SW	389	108	487	135	600	167
NOVA-H-1-1000x100-SW + R1-NOVA-1000x100	192	53	248	69	315	88
NOVA-H-1-1000x150-SW	610	170	759	211	928	258
NOVA-H-1-1000x150-SW + R1-NOVA-1000x150	300	83	386	107	487	135
NOVA-H-1-1000x200-SW	838	233	1034	287	1259	350
NOVA-H-1-1000x200-SW + R1-NOVA-1000x200	412	114	526	146	660	183
NOVA-H-1-1000x300-SW	1312	365	1608	447	1947	541
NOVA-H-1-1000x300-SW + R1-NOVA-1000x300	645	179	817	227	1021	284
NOVA-H-1-1000x400-SW	1803	501	2206	613	2662	740
NOVA-H-1-1000x400-SW + R1-NOVA-1000x400	887	246	1122	312	1397	388
NOVA-H-1-1000x500-SW	2302	640	2811	781	3382	939
NOVA-H-1-1000x500-SW + R1-NOVA-1000x500	1132	314	1429	397	1774	493
NOVA-H-1-1000x600-SW	2544	707	3189	886	3920	1089
NOVA-H-1-1000x600-SW + R1-NOVA-1000x600	1228	341	1601	445	2040	567
NOVA-H-1-1025x75-SW	900	250	900	250	900	250
NOVA-H-1-1025x75-SW + R1-NOVA-1025x75	900	250	900	250	900	250
NOVA-H-1-1025x125-SW	511	142	638	177	784	218
NOVA-H-1-1025x125-SW + R1-NOVA-1025x125	251	70	324	90	411	114
NOVA-H-1-1025x225-SW	983	273	1206	335	1466	407
NOVA-H-1-1025x225-SW + R1-NOVA-1025x225	483	134	613	170	769	214
NOVA-H-1-1025x325-SW	1470	408	1808	502	2188	608
NOVA-H-1-1025x325-SW + R1-NOVA-1025x325	723	201	919	255	1149	319
NOVA-H-1-1025x425-SW	1978	550	2418	672	2914	809
NOVA-H-1-1025x425-SW + R1-NOVA-1025x425	972	270	1230	342	1528	425
NOVA-H-1-1025x525-SW	2492	692	3049	847	3667	1018
NOVA-H-1-1025x525-SW + R1-NOVA-1025x525	1224	340	1350	375	1350	375
NOVA-H-1-1200x100-SW	477	132	593	165	726	202
NOVA-H-1-1200x100-SW + R1-NOVA-1200x100	234	65	301	84	381	106
NOVA-H-1-1200x150-SW	746	207	922	256	1125	312
NOVA-H-1-1200x150-SW + R1-NOVA-1200x150	367	102	469	130	590	164
NOVA-H-1-1200x200-SW	1024	284	1266	352	1540	428
NOVA-H-1-1200x200-SW + R1-NOVA-1200x200	503	140	644	179	808	224
NOVA-H-1-1200x300-SW	1607	446	1969	547	2380	661

Item	25 dB(A)		30 dB(A)		35 dB(A)	
	m ³ /h	l/s	m ³ /h	l/s	m ³ /h	l/s
NOVA-H-1-1200x300-SW + R1-NOVA-1200x300	790	219	1002	278	1249	347
NOVA-H-1-1200x400-SW	2202	612	2697	749	3247	902
NOVA-H-1-1200x400-SW + R1-NOVA-1200x400	1082	301	1372	381	1705	474
NOVA-H-1-1200x500-SW	2963	823	3614	1004	4339	1205
NOVA-H-1-1200x500-SW + R1-NOVA-1200x500	1457	405	1839	511	2278	633
NOVA-H-1-1200x600-SW	3450	958	4179	1161	5000	1389
NOVA-H-1-1200x600-SW + R1-NOVA-1200x600	1696	471	2124	590	2623	728
NOVA-H-1-1225x75-SW	900	250	900	250	900	250
NOVA-H-1-1225x75-SW + R1-NOVA-1225x75	900	250	900	250	900	250
NOVA-H-1-1225x125-SW	623	173	776	216	950	264
NOVA-H-1-1225x125-SW + R1-NOVA-1225x125	306	85	395	110	499	139
NOVA-H-1-1225x225-SW	1194	332	1468	408	1779	494
NOVA-H-1-1225x225-SW + R1-NOVA-1225x225	586	163	746	207	934	259
NOVA-H-1-1225x325-SW	1795	499	2195	610	2649	736
NOVA-H-1-1225x325-SW + R1-NOVA-1225x325	882	245	1116	310	1391	386
NOVA-H-1-1225x425-SW	2411	670	2940	817	3537	983
NOVA-H-1-1225x425-SW + R1-NOVA-1225x425	1186	329	1495	415	1857	516
NOVA-H-1-1225x525-SW	3045	846	3695	1026	4430	1230
NOVA-H-1-1225x525-SW + R1-NOVA-1225x525	1497	416	1878	522	2323	645
NOVA-H-1-1225x625-SW	3696	1027	4477	1244	5358	1488
NOVA-H-1-1225x625-SW + R1-NOVA-1225x625	1818	505	2277	632	2812	781

Air flow volume q_v at different A-weighted sound pressure levels L_{pA} with 10m² absorption area

Item	20 dB(A)		25 dB(A)		30 dB(A)	
	m ³ /h	l/s	m ³ /h	l/s	m ³ /h	l/s
NOVA-H-1-200x100-SW	62	17	80	22	102	28
NOVA-H-1-200x100-SW + R1-NOVA-200x100	30	8	41	11	53	15
NOVA-H-1-200x150-SW	98	27	125	35	156	43
NOVA-H-1-200x150-SW + R1-NOVA-200x150	48	13	63	17	82	23
NOVA-H-1-200x200-SW	135	38	171	47	213	59
NOVA-H-1-200x200-SW + R1-NOVA-200x200	66	18	86	24	111	31
NOVA-H-1-225x75-SW	780	217	780	217	780	217
NOVA-H-1-225x75-SW + R1-NOVA-225x75	735	204	735	204	735	204
NOVA-H-1-225x125-SW	91	25	117	32	146	41
NOVA-H-1-225x125-SW + R1-NOVA-225x125	45	12	59	16	77	21
NOVA-H-1-225x225-SW	174	48	222	62	277	77
NOVA-H-1-225x225-SW + R1-NOVA-225x225	85	23	112	31	144	40
NOVA-H-1-300x100-SW	99	27	125	35	156	43
NOVA-H-1-300x100-SW + R1-NOVA-300x100	48	13	63	17	82	23
NOVA-H-1-300x150-SW	154	43	194	54	242	67
NOVA-H-1-300x150-SW + R1-NOVA-300x150	75	21	98	27	126	35
NOVA-H-1-300x200-SW	211	59	266	74	330	92
NOVA-H-1-300x200-SW + R1-NOVA-300x200	103	29	135	37	173	48
NOVA-H-1-300x300-SW	330	92	415	115	514	143
NOVA-H-1-300x300-SW + R1-NOVA-300x300	161	45	210	58	268	74
NOVA-H-1-325x75-SW	862	239	862	239	862	239
NOVA-H-1-325x75-SW + R1-NOVA-325x75	765	212	765	212	765	212
NOVA-H-1-325x125-SW	137	38	175	48	218	61
NOVA-H-1-325x125-SW + R1-NOVA-325x125	67	18	88	24	114	32
NOVA-H-1-325x225-SW	262	73	331	92	411	114
NOVA-H-1-325x225-SW + R1-NOVA-325x225	127	35	167	46	214	59
NOVA-H-1-325x325-SW	393	109	495	137	611	170
NOVA-H-1-325x325-SW + R1-NOVA-325x325	192	53	250	69	319	89
NOVA-H-1-400x100-SW	134	37	171	47	214	59
NOVA-H-1-400x100-SW + R1-NOVA-400x100	65	18	86	24	112	31
NOVA-H-1-400x150-SW	211	59	267	74	332	92
NOVA-H-1-400x150-SW + R1-NOVA-400x150	103	29	135	37	173	48
NOVA-H-1-400x200-SW	290	81	365	101	451	125
NOVA-H-1-400x200-SW + R1-NOVA-400x200	142	39	184	51	235	65
NOVA-H-1-400x300-SW	456	127	568	158	696	193
NOVA-H-1-400x300-SW + R1-NOVA-400x300	223	62	286	79	363	101
NOVA-H-1-400x400-SW	628	174	777	216	951	264
NOVA-H-1-400x400-SW + R1-NOVA-400x400	307	85	393	109	495	138

Item	20 dB(A)		25 dB(A)		30 dB(A)	
	m ³ /h	l/s	m ³ /h	l/s	m ³ /h	l/s
NOVA-H-1-425x75-SW	900	250	900	250	900	250
NOVA-H-1-425x75-SW + R1-NOVA-425x75	795	221	795	221	795	221
NOVA-H-1-425x125-SW	186	52	234	65	290	81
NOVA-H-1-425x125-SW + R1-NOVA-425x125	91	25	118	33	152	42
NOVA-H-1-425x225-SW	352	98	444	123	549	153
NOVA-H-1-425x225-SW + R1-NOVA-425x225	172	48	224	62	287	80
NOVA-H-1-425x325-SW	532	148	662	184	812	225
NOVA-H-1-425x325-SW + R1-NOVA-425x325	260	72	335	93	423	118
NOVA-H-1-425x425-SW	715	199	891	247	1090	303
NOVA-H-1-425x425-SW + R1-NOVA-425x425	349	97	450	125	569	158
NOVA-H-1-500x100-SW	173	48	219	61	273	76
NOVA-H-1-500x100-SW + R1-NOVA-500x100	85	23	111	31	142	40
NOVA-H-1-500x150-SW	269	75	341	95	422	117
NOVA-H-1-500x150-SW + R1-NOVA-500x150	132	37	172	48	220	61
NOVA-H-1-500x200-SW	371	103	467	130	576	160
NOVA-H-1-500x200-SW + R1-NOVA-500x200	181	50	236	66	301	84
NOVA-H-1-500x300-SW	584	162	724	201	887	246
NOVA-H-1-500x300-SW + R1-NOVA-500x300	285	79	366	102	462	128
NOVA-H-1-500x400-SW	802	223	993	276	1211	336
NOVA-H-1-500x400-SW + R1-NOVA-500x400	391	109	502	139	631	175
NOVA-H-1-500x500-SW	1022	284	1268	352	1545	429
NOVA-H-1-500x500-SW + R1-NOVA-500x500	498	138	640	178	806	224
NOVA-H-1-525x75-SW	900	250	900	250	900	250
NOVA-H-1-525x75-SW + R1-NOVA-525x75	825	229	825	229	825	229
NOVA-H-1-525x125-SW	232	65	295	82	365	101
NOVA-H-1-525x125-SW + R1-NOVA-525x125	114	32	149	41	190	53
NOVA-H-1-525x225-SW	446	124	560	155	690	192
NOVA-H-1-525x225-SW + R1-NOVA-525x225	218	60	283	78	360	100
NOVA-H-1-525x325-SW	669	186	835	232	1025	285
NOVA-H-1-525x325-SW + R1-NOVA-525x325	327	91	422	117	534	148
NOVA-H-1-525x425-SW	907	252	1118	311	1361	378
NOVA-H-1-525x425-SW + R1-NOVA-525x425	443	123	565	157	710	197
NOVA-H-1-525x525-SW	1143	318	1410	392	1713	476
NOVA-H-1-525x525-SW + R1-NOVA-525x525	558	155	712	198	893	248
NOVA-H-1-600x100-SW	211	59	267	74	332	92
NOVA-H-1-600x100-SW + R1-NOVA-600x100	103	29	135	37	173	48
NOVA-H-1-600x150-SW	328	91	416	115	515	143
NOVA-H-1-600x150-SW + R1-NOVA-600x150	161	45	210	58	269	75
NOVA-H-1-600x200-SW	454	126	570	158	701	195

Item	20 dB(A)		25 dB(A)		30 dB(A)	
	m ³ /h	l/s	m ³ /h	l/s	m ³ /h	l/s
NOVA-H-1-600x200-SW + R1-NOVA-600x200	221	61	288	80	366	102
NOVA-H-1-600x300-SW	716	199	884	245	1079	300
NOVA-H-1-600x300-SW + R1-NOVA-600x300	350	97	446	124	563	156
NOVA-H-1-600x400-SW	983	273	1211	336	1473	409
NOVA-H-1-600x400-SW + R1-NOVA-600x400	480	133	612	170	768	213
NOVA-H-1-600x500-SW	1256	349	1547	430	1876	521
NOVA-H-1-600x500-SW + R1-NOVA-600x500	613	170	781	217	978	272
NOVA-H-1-625x75-SW	900	250	900	250	900	250
NOVA-H-1-625x75-SW + R1-NOVA-625x75	862	239	862	239	862	239
NOVA-H-1-625x125-SW	282	78	357	99	441	123
NOVA-H-1-625x125-SW + R1-NOVA-625x125	137	38	180	50	230	64
NOVA-H-1-625x225-SW	541	150	677	188	833	231
NOVA-H-1-625x225-SW + R1-NOVA-625x225	264	73	342	95	434	121
NOVA-H-1-625x325-SW	814	226	1010	281	1233	342
NOVA-H-1-625x325-SW + R1-NOVA-625x325	398	110	510	142	643	178
NOVA-H-1-625x425-SW	1104	307	1357	377	1648	458
NOVA-H-1-625x425-SW + R1-NOVA-625x425	539	150	686	190	860	239
NOVA-H-1-625x525-SW	1391	386	1711	475	2074	576
NOVA-H-1-625x525-SW + R1-NOVA-625x525	679	189	865	240	1082	301
NOVA-H-1-800x100-SW	290	81	366	102	452	126
NOVA-H-1-800x100-SW + R1-NOVA-800x100	142	39	185	51	236	66
NOVA-H-1-800x150-SW	454	126	568	158	699	194
NOVA-H-1-800x150-SW + R1-NOVA-800x150	222	62	287	80	364	101
NOVA-H-1-800x200-SW	626	174	780	217	956	266
NOVA-H-1-800x200-SW + R1-NOVA-800x200	306	85	394	109	499	139
NOVA-H-1-800x300-SW	982	273	1212	337	1474	410
NOVA-H-1-800x300-SW + R1-NOVA-800x300	479	133	612	170	769	214
NOVA-H-1-800x400-SW	1344	373	1664	462	2021	561
NOVA-H-1-800x400-SW + R1-NOVA-800x400	656	182	841	234	1054	293
NOVA-H-1-800x500-SW	1722	478	2119	589	2566	713
NOVA-H-1-800x500-SW + R1-NOVA-800x500	840	233	1070	297	1339	372
NOVA-H-1-825x75-SW	900	250	900	250	900	250
NOVA-H-1-825x75-SW + R1-NOVA-825x75	900	250	900	250	900	250
NOVA-H-1-825x125-SW	383	107	482	134	595	165
NOVA-H-1-825x125-SW + R1-NOVA-825x125	187	52	244	68	311	86
NOVA-H-1-825x225-SW	740	206	914	254	1116	310
NOVA-H-1-825x225-SW + R1-NOVA-825x225	361	100	462	128	582	162
NOVA-H-1-825x325-SW	1106	307	1370	381	1668	463
NOVA-H-1-825x325-SW + R1-NOVA-825x325	540	150	692	192	870	242

Item	20 dB(A)		25 dB(A)		30 dB(A)	
	m ³ /h	l/s	m ³ /h	l/s	m ³ /h	l/s
NOVA-H-1-825x425-SW	1490	414	1837	510	2226	618
NOVA-H-1-825x425-SW + R1-NOVA-825x425	727	202	928	258	1162	323
NOVA-H-1-825x525-SW	1877	521	2313	643	2798	777
NOVA-H-1-825x525-SW + R1-NOVA-825x525	915	254	1169	325	1460	406
NOVA-H-1-1000x100-SW	371	103	466	130	576	160
NOVA-H-1-1000x100-SW + R1-NOVA-1000x100	181	50	235	65	301	84
NOVA-H-1-1000x150-SW	583	162	728	202	893	248
NOVA-H-1-1000x150-SW + R1-NOVA-1000x150	284	79	368	102	466	129
NOVA-H-1-1000x200-SW	802	223	993	276	1211	336
NOVA-H-1-1000x200-SW + R1-NOVA-1000x200	391	109	502	139	631	175
NOVA-H-1-1000x300-SW	1258	349	1546	429	1875	521
NOVA-H-1-1000x300-SW + R1-NOVA-1000x300	614	171	781	217	978	272
NOVA-H-1-1000x400-SW	1728	480	2121	589	2566	713
NOVA-H-1-1000x400-SW + R1-NOVA-1000x400	843	234	1072	298	1339	372
NOVA-H-1-1000x500-SW	2206	613	2705	751	3262	906
NOVA-H-1-1000x500-SW + R1-NOVA-1000x500	1076	299	1366	379	1701	473
NOVA-H-1-1000x600-SW	2423	673	3054	848	3766	1046
NOVA-H-1-1000x600-SW + R1-NOVA-1000x600	1160	322	1522	423	1946	541
NOVA-H-1-1025x75-SW	900	250	900	250	900	250
NOVA-H-1-1025x75-SW + R1-NOVA-1025x75	900	250	900	250	900	250
NOVA-H-1-1025x125-SW	488	136	611	170	753	209
NOVA-H-1-1025x125-SW + R1-NOVA-1025x125	238	66	309	86	392	109
NOVA-H-1-1025x225-SW	941	261	1159	322	1411	392
NOVA-H-1-1025x225-SW + R1-NOVA-1025x225	459	128	586	163	735	204
NOVA-H-1-1025x325-SW	1407	391	1738	483	2108	586
NOVA-H-1-1025x325-SW + R1-NOVA-1025x325	687	191	878	244	1100	306
NOVA-H-1-1025x425-SW	1895	526	2327	646	2809	780
NOVA-H-1-1025x425-SW + R1-NOVA-1025x425	924	257	1175	327	1465	407
NOVA-H-1-1025x525-SW	2388	663	2933	815	3538	983
NOVA-H-1-1025x525-SW + R1-NOVA-1025x525	1164	323	1350	375	1350	375
NOVA-H-1-1200x100-SW	456	127	568	158	698	194
NOVA-H-1-1200x100-SW + R1-NOVA-1200x100	222	62	287	80	363	101
NOVA-H-1-1200x150-SW	713	198	885	246	1082	300
NOVA-H-1-1200x150-SW + R1-NOVA-1200x150	348	97	447	124	564	157
NOVA-H-1-1200x200-SW	978	272	1216	338	1482	412
NOVA-H-1-1200x200-SW + R1-NOVA-1200x200	478	133	615	171	774	215
NOVA-H-1-1200x300-SW	1539	427	1893	526	2293	637
NOVA-H-1-1200x300-SW + R1-NOVA-1200x300	751	209	956	266	1196	332
NOVA-H-1-1200x400-SW	2109	586	2594	721	3132	870

Item	20 dB(A)		25 dB(A)		30 dB(A)	
	m ³ /h	l/s	m ³ /h	l/s	m ³ /h	l/s
NOVA-H-1-1200x400-SW + R1-NOVA-1200x400	1029	286	1311	364	1634	454
NOVA-H-1-1200x500-SW	2841	789	3479	966	4187	1163
NOVA-H-1-1200x500-SW + R1-NOVA-1200x500	1387	385	1758	488	2185	607
NOVA-H-1-1200x600-SW	3313	920	4026	1118	4827	1341
NOVA-H-1-1200x600-SW + R1-NOVA-1200x600	1617	449	2033	565	2517	699
NOVA-H-1-1225x75-SW	900	250	900	250	900	250
NOVA-H-1-1225x75-SW + R1-NOVA-1225x75	900	250	900	250	900	250
NOVA-H-1-1225x125-SW	594	165	744	207	913	254
NOVA-H-1-1225x125-SW + R1-NOVA-1225x125	290	80	376	104	477	132
NOVA-H-1-1225x225-SW	1142	317	1410	392	1713	476
NOVA-H-1-1225x225-SW + R1-NOVA-1225x225	557	155	712	198	893	248
NOVA-H-1-1225x325-SW	1721	478	2111	586	2554	709
NOVA-H-1-1225x325-SW + R1-NOVA-1225x325	840	233	1066	296	1332	370
NOVA-H-1-1225x425-SW	2312	642	2829	786	3412	948
NOVA-H-1-1225x425-SW + R1-NOVA-1225x425	1129	314	1430	397	1780	494
NOVA-H-1-1225x525-SW	2923	812	3558	988	4275	1187
NOVA-H-1-1225x525-SW + R1-NOVA-1225x525	1427	396	1797	499	2229	619
NOVA-H-1-1225x625-SW	3550	986	4314	1198	5173	1437
NOVA-H-1-1225x625-SW + R1-NOVA-1225x625	1733	481	2180	605	2698	749

Technical Parameters

Diagrams and technical parameters are available at design.systemair.com

Installation

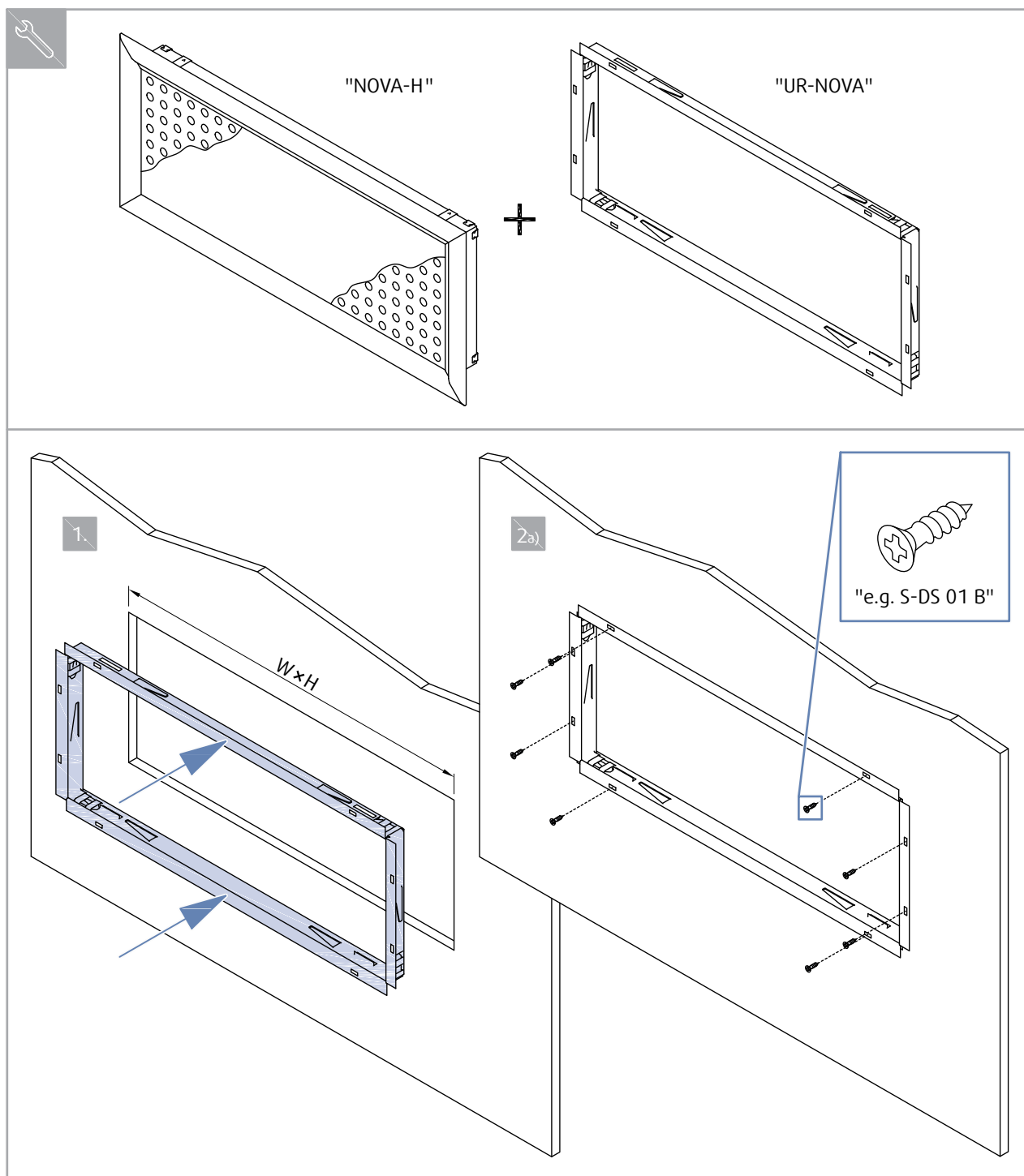

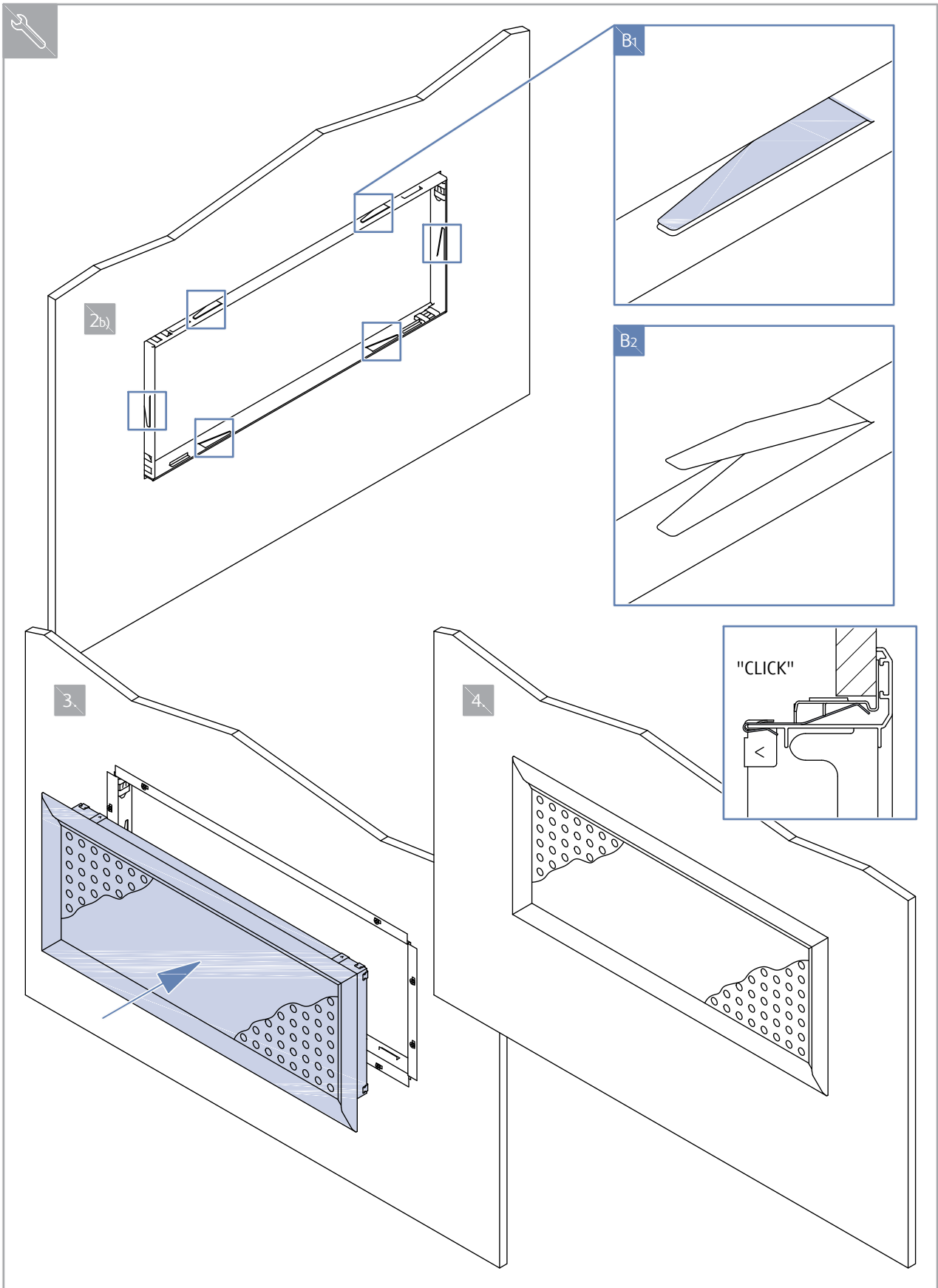

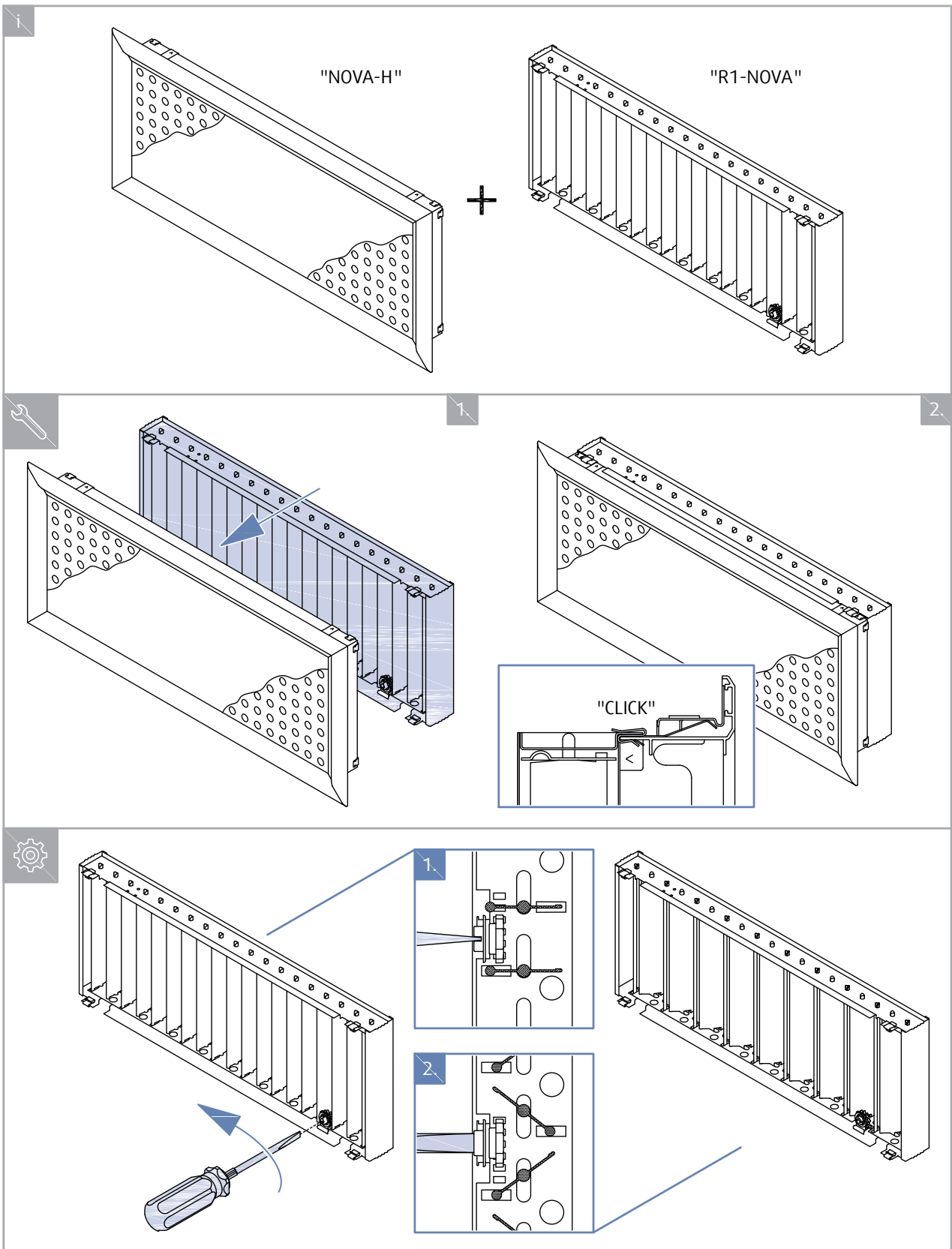

Transport, Storage and Operation

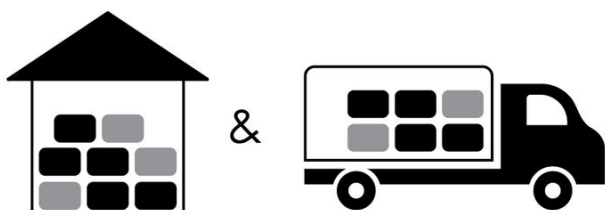

 °C -40 °C ... +50 °C

 % ≤ 95%



 °C -20 °C ... +70 °C

 % ≤ 95%

Supplement

Any deviations from the technical specifications contained herein and the terms should be discussed with the manufacturer. We reserve the right to make any changes to the product without prior notice, provided that these changes do not affect the quality of the product and the required parameters.

Current information on all products is available on design.systemair.com.

