

Air Grilles and Diffusion Grilles – NOVA series

The Best Solution for Your Ventilation

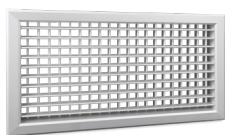

Contents



NOVA-A 3
Single- or double-row aluminium diffusion grille with adjustable blades for air supply or air extract.



NOVA-R 19
Non-transparent aluminium wall grille for air extract.

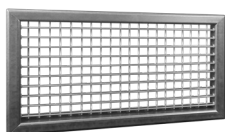

NOVA-B 7
Single- or double-row steel diffusion grille with adjustable blades for air supply or air extract.



NOVA-E 21
Extract grille with a square profile for large air volume extracts with an option to be inserted into a T-bar ceiling.

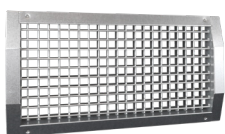

NOVA-C
All information about NOVA-C is available at design.systemair.com



NOVA-D 23
Door grille with a non-transparent blade alignment.



NOVA-L 11
Single- or double-row aluminium grille with fixed blades for air supply or air extract with an option to create a continuous line of grilles.



Accessories 25
Damper, mounting frame, G4 filter and plenum boxes designed for the NOVA series.



NOVA-S 17
Window sill aluminium grille with fixed blades for air supply or air extract.



Good to know

Current information on all products is available at design.systemair.com

NOVA-A

An Aluminium Diffusion Grille for Rectangular Ducts

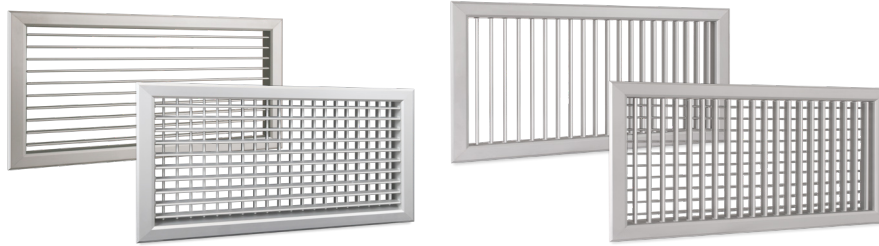

Ordering Code

		NOVA-A -	□	□	□	□	□	□
Single-row		1						
Double-row		2						
Mounting ¹	screws	1						
	spring clips	2						
	safety mounting mechanism	3						
Dimensions		L × H						
Damper		R1						
Mounting frame ¹		UR						
Blades	horizontal	H						
	vertical ²	V						
Surface finish ³	anodized	AN						
	RAL9003	SW						
	other RAL color	RAL						

Ordering code example:

NOVA-A - 2 - 2 - 400 × 200 - R1 - UR - H - RAL9010

An aluminium grille for rectangular ducts with two rows of blades and mounting with spring clips, intended for a structural opening with dimensions 400 × 200 mm, R1-NOVA damper, mounting frame included, with the first row of blades horizontally oriented and a powder paint RAL 9010 surface finish.

1. The mounting frame is not automatically included in a standard order for mounting types "1" and "2"; if interested, please remember to add the "UR" option into the ordering code.
In case of mounting type "3", there is no need to enter the "UR" into the ordering code (it will be automatically included in the delivery).
2. In case the blade alignment – horizontal (H) or vertical (V) – is not specified in the ordering code, the product with a horizontal blade alignment (H) will be delivered as default.
3. In case the RAL surface finish is not specified in the ordering code, the product will be delivered with a natural eloxal surface finish as default. If a RAL color different from RAL9003 is required, then „RAL“ shall be written in the ordering code. The exact color definition - the RAL number - shall be stated in the notes of the order.

Description

NOVA-A is a rectangular aluminium diffusion grille with one or two rows of adjustable blades. It is adequate for usage in such premises that require a higher emphasis on appearance. The NOVA-A diffusion grille directs the air using its adjustable blades in a horizontal, as well as vertical direction. It is designed for air supply and air extract. For a balanced distribution of air through the entire diffusion grille it is recommended to use a damper or a plenum box.

Information about the NOVA-A accessories is available on page 25.

- R1-NOVA – damper
- UR-NOVA – mounting frame
- ODEN – plenum box
- PB-NOVA – plenum box

Mounting

The NOVA-A diffusion grille can be mounted directly onto a rectangular duct using countersunk screws (type “1” mounting), or onto a wall using a mounting frame and spring clips (type “2” mounting + UR) and, if appropriate, it can also be placed onto a wall and a ceiling using a mounting frame and a safety mounting mechanism (type “3” mounting).

The type “3” safety mounting mechanism consists of a ratchet/spring combination which enables the fixing of the grille by sliding it into the mounting frame with no tools required. To detach the grille from the frame the ratchet springs shall be one by one pressed by a flat screwdriver towards the grille body pulling the grille out of the frame.

IMPORTANT: For fixing type “3” the size of the installation opening for the mounting frame must be exactly according to the specification in this document (H x L dimension in the dimensions table). The mounting frame after installation must not be deformed by external forces (like by mounting into improperly formed and sized installation opening, etc.) For sufficient safety the grilles with more than 4 fixing type “3” spring ratchets (dimension L of 600 mm or larger) are equipped by 2 chains. These must be fixed to the adjacent rigid building structure.

Design

Material used:

The NOVA-A diffusion grille is manufactured from aluminium profiles with eloxal coating or, if appropriate, a powder-lacquered (RAL 9003 - signal white) surface finish; other RAL types are available upon request. The operation temperature range is -20 to 100°C

Type of blades:

Single-row as well as double-row diffusion grilles can have both horizontal and vertical front blade alignment. The second row of blades is always perpendicular to the first row. The blades’ axial pitch is 20 mm.

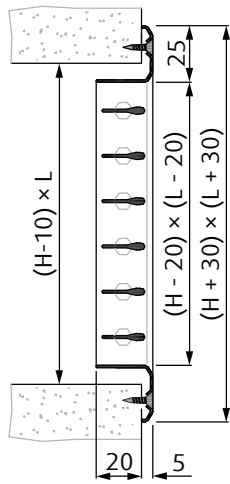

NOVA-A-1-1-LxH-H

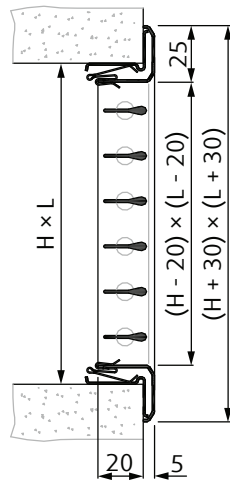

NOVA-A-1-2-LxH-H-UR

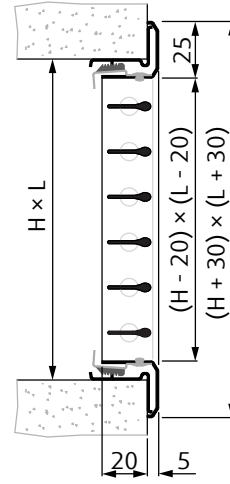

NOVA-A-1-3-LxH-H

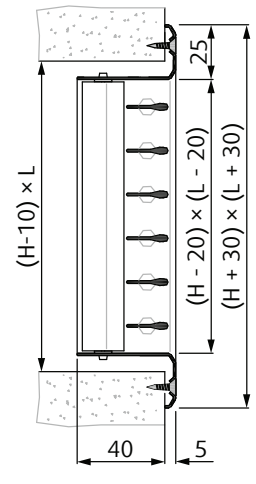

NOVA-A-2-1-LxH-H

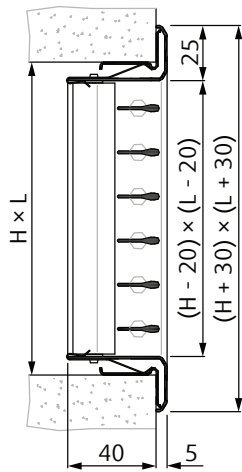

NOVA-A-2-2-LxH-H-UR

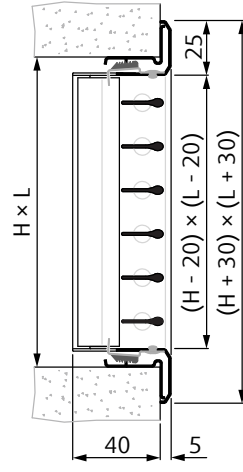

NOVA-A-2-3-LxH-H

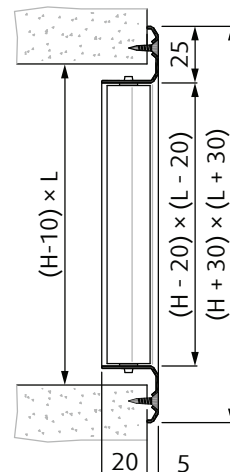

NOVA-A-1-1-LxH-V

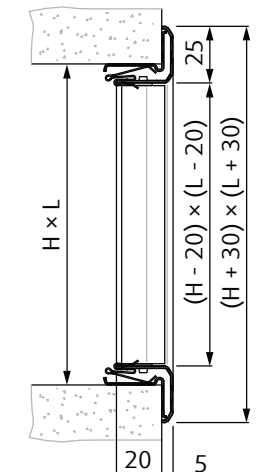

NOVA-A-1-2-LxH-V-UR

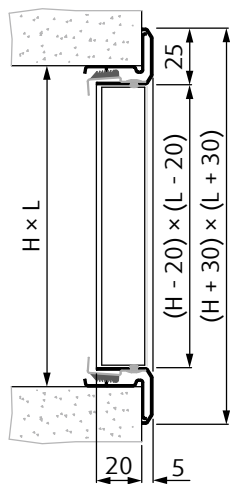

NOVA-A-1-3-LxH-V

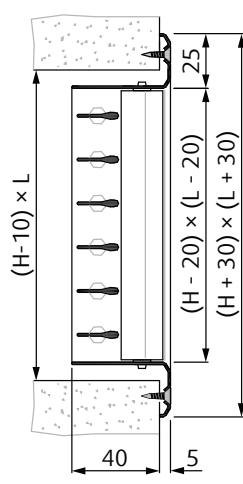

NOVA-A-2-1-LxH-V

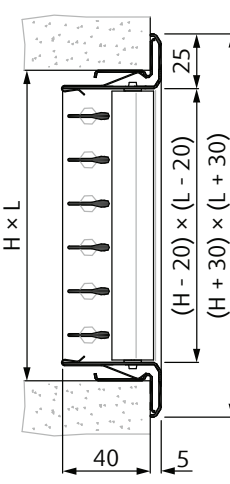

NOVA-A-2-2-LxH-V-UR

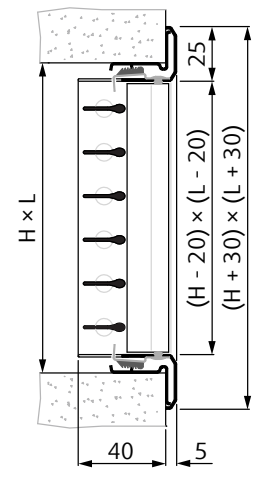

NOVA-A-2-3-LxH-V

Fig. 1: Basic NOVA-A dimensions and diffusion grille types

* **IMPORTANT:** for installation and security information to the safety mounting mechanism „3” see the article „Mounting“.

Technical Details

Dimensions

Dimensions		Free area		Weight		
L	H	A _{v1}	A _{v2}	m ₁	m ₂	
(mm)		(m ²)		(kg)		
200	100	0,012	0,009	0,20	0,30	
	150	0,019	0,016	0,25	0,40	
	200	0,026	0,021	0,32	0,52	
300	100	0,018	0,015	0,27	0,42	
	150	0,030	0,024	0,34	0,57	
	200	0,041	0,033	0,44	0,73	
300	300	0,064	0,051	0,60	1,04	
	400	100	0,025	0,020	0,34	0,54
		150	0,041	0,033	0,43	0,73
200		0,055	0,045	0,55	0,95	
300		0,086	0,070	0,77	1,35	
400	400	0,117	0,095	0,98	1,75	
	500	100	0,031	0,025	0,41	0,67
		150	0,051	0,042	0,52	0,89
		200	0,070	0,057	0,67	1,16
300		0,109	0,088	0,93	1,66	
400		0,148	0,120	1,19	2,16	
500	500	0,187	0,151	1,45	2,65	
	600	100	0,038	0,030	0,48	0,79
		150	0,062	0,050	0,61	1,05
		200	0,085	0,068	0,79	1,38
		300	0,132	0,107	1,10	1,97
400		0,179	0,145	1,40	2,56	
600	500	0,226	0,183	1,71	3,15	
	800	100	0,051	0,041	0,63	1,03
		150	0,084	0,068	0,79	1,38
		200	0,114	0,092	1,03	1,81
		300	0,177	0,143	1,43	2,58
400		0,240	0,194	1,83	3,36	
800	500	0,303	0,246	2,23	4,14	
	1000	100	0,064	0,051	0,77	1,27
		150	0,105	0,085	0,97	1,71
		200	0,143	0,116	1,26	2,23
		300	0,222	0,180	1,76	3,20
400		0,302	0,244	2,25	4,17	
1000	500	0,381	0,309	2,74	5,13	
	1200	100	0,076	0,062	0,91	1,51
		150	0,126	0,102	1,15	2,03
		200	0,172	0,139	1,50	2,66
		300	0,268	0,217	2,09	3,82
400		0,363	0,294	2,67	4,97	
1200	500	0,459	0,372	3,26	6,13	

Dimensions		Free area		Weight		
L	H	A _{v1}	A _{v2}	m ₁	m ₂	
(mm)		(m ²)		(kg)		
225	75	0,010	0,008	0,17	0,26	
	125	0,018	0,014	0,25	0,39	
	225	0,034	0,028	0,38	0,62	
325	75	0,014	0,012	0,22	0,35	
	125	0,026	0,021	0,33	0,53	
	225	0,051	0,041	0,50	0,86	
	325	0,076	0,062	0,68	1,19	
425	75	0,019	0,016	0,28	0,44	
	125	0,035	0,028	0,41	0,67	
	225	0,068	0,055	0,63	1,09	
	325	0,100	0,082	0,85	1,52	
	425	0,133	0,108	1,08	1,94	
525	75	0,024	0,019	0,33	0,53	
	125	0,043	0,035	0,49	0,81	
	225	0,084	0,068	0,76	1,33	
	325	0,125	0,102	1,03	1,85	
	425	0,166	0,135	1,30	2,36	
525	525	0,207	0,168	1,57	2,88	
	625	75	0,029	0,023	0,38	0,62
		125	0,052	0,042	0,57	0,95
		225	0,101	0,082	0,88	1,56
		325	0,150	0,122	1,20	2,18
425		0,199	0,162	1,52	2,79	
625	525	0,248	0,201	1,84	3,40	
	825	75	0,038	0,031	0,48	0,80
		125	0,069	0,056	0,73	1,24
		225	0,134	0,109	1,14	2,04
		325	0,200	0,162	1,55	2,84
425		0,265	0,215	1,96	3,64	
825	525	0,330	0,268	2,37	4,44	
	1025	75	0,048	0,039	0,59	0,98
		125	0,086	0,070	0,89	1,52
		225	0,168	0,136	1,39	2,51
		325	0,249	0,202	1,90	3,50
425		0,331	0,268	2,41	4,48	
1025	525	0,412	0,334	2,91	5,47	
	1225	75	0,057	0,046	0,69	1,16
		125	0,104	0,084	1,05	1,80
		225	0,201	0,163	1,65	2,98
		325	0,299	0,242	2,25	4,15
425		0,396	0,321	2,85	5,33	
1225	525	0,494	0,401	3,45	6,51	

A_{v1}, m₁, ...NOVA-A-1 - single-row
 A_{v2}, m₂, ...NOVA-A-2 - double-row

Tab. 1: Dimensions, free area and weight of the NOVA-A diffusion grilles

NOVA-B

A Steel Diffusion Grille for Rectangular Ducts

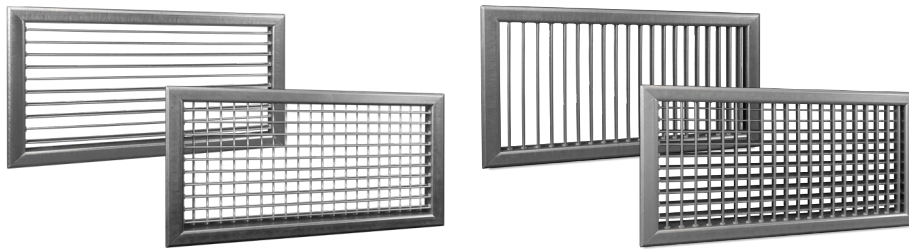

Ordering Codes

Galvanized steel grille

		NOVA-B-	□	□	□	□	□	□
Single-row		1	□	□	□	□	□	□
Double-row		2	□	□	□	□	□	□
	screws ¹	1	□	□	□	□	□	□
	spring clips ¹	2	□	□	□	□	□	□
Mounting	safety mounting mechanism	3	□	□	□	□	□	□
Dimensions	L × H		□	□	□	□	□	□
Damper	R1		□	□	□	□	□	□
Mounting frame ¹	UR		□	□	□	□	□	□
Blades	horizontal ²	H	□	□	□	□	□	□
	vertical	V	□	□	□	□	□	□
Surface finish ³	galvanized	ZN	□	□	□	□	□	□
	RAL9003	SW	□	□	□	□	□	□
	other RAL color	RAL	□	□	□	□	□	□

Ordering code example:

NOVA-B - 2 - 3 - 625 × 125 - R1 - H - SW

A steel diffusion grille for rectangular ducts with two rows of blades, with a safety mounting mechanism (including UR), intended for a structural opening with dimensions 625 × 125 mm, powder painted R1-NOVA damper with the first row of blades horizontally oriented and a RAL 9003 surface finish of the grille.

1. The mounting frame is not automatically included in a standard order for mounting types "1" and "2", if interested, please remember to add the "UR" option into the ordering code. In case of mounting type "3", there is no need to enter the "UR" into the ordering code (it will be automatically included in the delivery).
2. In case the blade alignment – horizontal (H) or vertical (V) – is not specified in the ordering code, the product with a horizontal blade alignment (H) will be delivered as default.
3. In case the RAL surface finish is not specified in the ordering code, the product will be delivered with a galvanized sheet surface finish as default. If a RAL color different from RAL9003 is required, then „RAL" shall be written in the ordering code. The exact color definition - the RAL number - shall be stated in the notes of the order.

Stainless steel grille

		NOVA-BN-	□	□	□	□	□	□
Single-row		1	□	□	□	□	□	□
Double-row		2	□	□	□	□	□	□
Dimensions	L × H		□	□	□	□	□	□
Damper	RN1		□	□	□	□	□	□
Blades	horizontal ¹	H	□	□	□	□	□	□
	vertical	V	□	□	□	□	□	□
Stainless steel type	A304	A2	□	□	□	□	□	□
	A316	A4	□	□	□	□	□	□

Ordering code example:

NOVA-BN - 1 - 625 × 125 - R1 - H - A2

Stainless steel A304 diffusion grille for rectangular ducts with a single layer of horizontally oriented blades. Fit in structure opening 625x125mm. Stainless steel adjustment R1-NOVA damper added.

1. In case the blade alignment – horizontal (H) or vertical (V) – is not specified in the ordering code, the product with a horizontal blade alignment (H) will be delivered as default.

Description

NOVA-B is a rectangular steel diffusion grille with one or two rows of adjustable blades. It is adequate for usage as a standard ventilation element in industrial and commercial premises. The NOVA-B diffusion grille directs the air using its adjustable blades in a horizontal, as well as vertical direction. It is designed for air supply and air extract. For a balanced distribution of air through the entire diffusion grille it is recommended to use a damper or a plenum box.

Information about the NOVA-B accessories is available from page 25.

- R1-NOVA – damper
- UR-NOVA – mounting frame
- ODEN – plenum box
- PB-NOVA – plenum box

Mounting

The NOVA-B diffusion grille can be mounted directly onto a duct using countersunk screws (type "1" mounting), or onto a wall using a mounting frame and spring clips (type "2" mounting + UR) and, if appropriate, it can also be placed onto a wall and a ceiling using a mounting frame and a safety mounting mechanism (type "3" mounting).

The type "3" safety mounting mechanism consists of a ratchet/spring combination which enables the fixing of the grille by sliding it into the mounting frame with no tools required. To detach the grille from the frame the ratchet springs shall be one by one pressed by a flat screwdriver towards the grille body pulling the grille out of the frame.

IMPORTANT: For fixing type "3" the size of the installation opening for the mounting frame must be exactly according to the specification in this document (H x L dimension in the dimensions table). The mounting frame after installation must not be deformed by external forces (like by mounting into improperly formed and sized installation opening, etc.) For sufficient safety the grilles with more than 4 fixing type "3" spring ratchets (dimension L of 600 mm or larger) are equipped by 2 chains. These must be fixed to the adjacent rigid building structure.

Design

Material used:

The NOVA-B diffusion grille is manufactured from galvanized steel profiles with, if appropriate, a powder-lacquered (RAL 9003 - signal white) surface finish; other RAL types are available upon request, as well as an A-304 (A2 in ordering code) or A-316 (A4 in ordering code) stainless steel version of the product. The operation temperature range is -20 to 100°C

Type of blades:

Single-row as well as double-row diffusion grilles can have both horizontal and vertical front blade alignment. The second row of blades is always perpendicular to the first row. The blades' axial pitch is 20 mm.

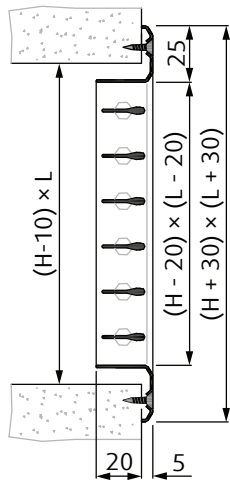

NOVA-B-1-1-LxH-H

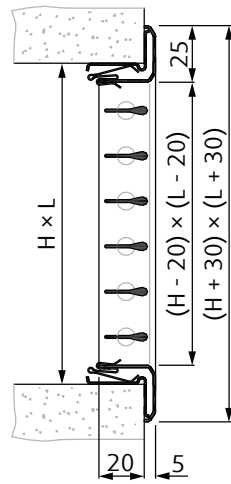

NOVA-B-1-2-LxH-H-UR

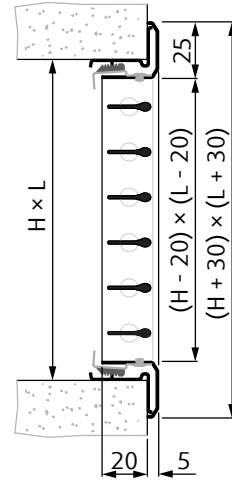

NOVA-B-1-3-LxH-H

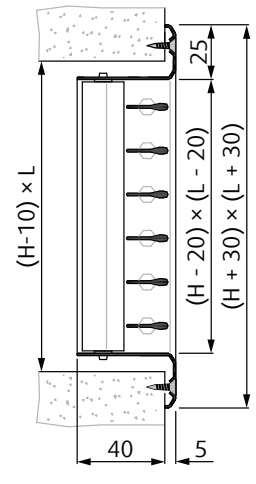

NOVA-B-2-1-LxH-H

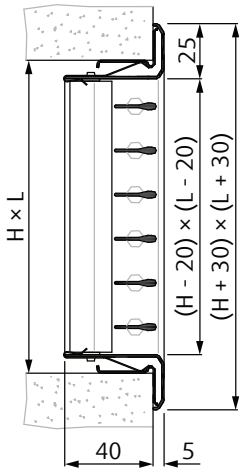

NOVA-B-2-2-LxH-H-UR

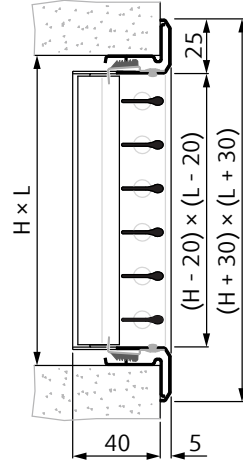

NOVA-B-2-3-LxH-H

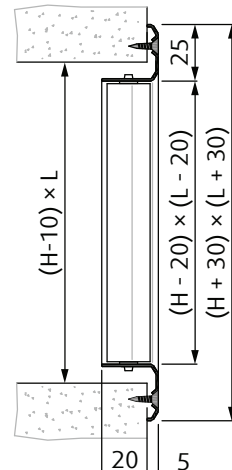

NOVA-B-1-1-LxH-V

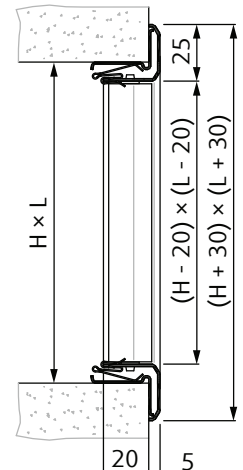

NOVA-B-1-2-LxH-V-UR

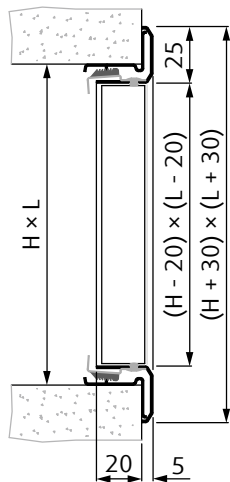

NOVA-B-1-3-LxH-V

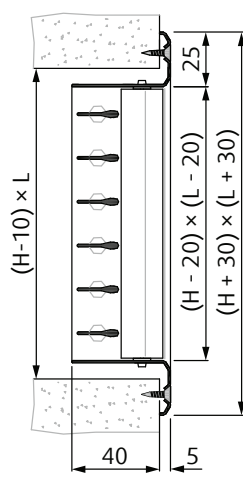

NOVA-B-2-1-LxH-V

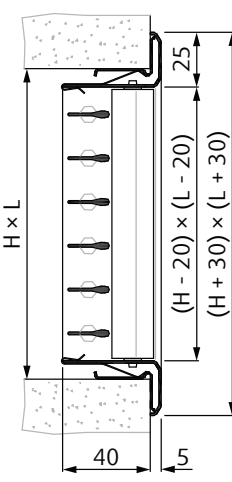

NOVA-B-2-2-LxH-V-UR

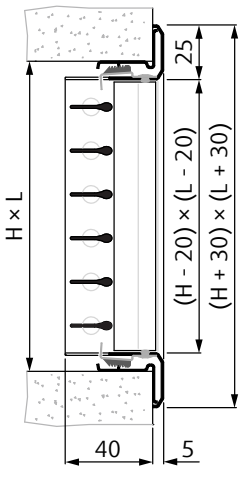

NOVA-B-2-3-LxH-V

Fig. 2: Basic NOVA-B dimensions and diffusion grille types

* **IMPORTANT:** for installation and security information to the safety mounting mechanism „3” see the article „Mounting“.

Technical Details

Dimensions

Dimensions		Free area		Weight		
L	H	A _{v1}	A _{v2}	m ₁	m ₂	
(mm)		(m ²)		(kg)		
200	100	0,012	0,009	0,32	0,54	
	150	0,019	0,016	0,45	0,77	
	200	0,026	0,021	0,54	0,97	
300	100	0,018	0,015	0,45	0,78	
	150	0,030	0,024	0,64	1,11	
	200	0,041	0,033	0,77	1,39	
300	300	0,064	0,051	1,08	2,00	
	400	100	0,025	0,020	0,58	1,02
		150	0,041	0,033	0,82	1,45
200		0,055	0,045	0,99	1,82	
300		0,086	0,070	1,40	2,61	
400	400	0,117	0,095	1,80	3,40	
	500	100	0,031	0,025	0,72	1,26
		150	0,051	0,042	1,01	1,79
		200	0,070	0,057	1,21	2,24
300		0,109	0,088	1,71	3,22	
400		0,148	0,120	2,21	4,20	
500	500	0,187	0,151	2,71	5,17	
	600	100	0,038	0,030	0,85	1,50
		150	0,062	0,050	1,20	2,13
		200	0,085	0,068	1,44	2,66
		300	0,132	0,107	2,03	3,83
400		0,179	0,145	2,62	4,99	
500		0,226	0,183	3,21	6,15	
800	100	0,051	0,041	1,11	1,98	
	150	0,084	0,068	1,57	2,82	
	200	0,114	0,092	1,89	3,51	
	300	0,177	0,143	2,66	5,04	
	400	0,240	0,194	3,44	6,58	
	500	0,303	0,246	4,22	8,11	
1000	100	0,064	0,051	1,37	2,46	
	150	0,105	0,085	1,94	3,50	
	200	0,143	0,116	2,33	4,36	
	300	0,222	0,180	3,29	6,26	
	400	0,302	0,244	4,26	8,16	
	500	0,381	0,309	5,22	10,06	
1200	100	0,076	0,062	1,64	2,93	
	150	0,126	0,102	2,32	4,18	
	200	0,172	0,139	2,78	5,21	
	300	0,268	0,217	3,93	7,48	
	400	0,363	0,294	5,07	9,75	
	500	0,459	0,372	6,22	12,02	

Dimensions		Free area		Weight	
L	H	A _{v1}	A _{v2}	m ₁	m ₂
(mm)		(m ²)		(kg)	
225	75	0,010	0,008	0,30	0,49
	125	0,018	0,014	0,41	0,71
	225	0,034	0,028	0,65	1,17
325	75	0,014	0,012	0,42	0,69
	125	0,026	0,021	0,56	0,99
	225	0,051	0,041	0,89	1,64
	325	0,076	0,062	1,23	2,29
425	75	0,019	0,016	0,53	0,89
	125	0,035	0,028	0,71	1,27
	225	0,068	0,055	1,14	2,10
	325	0,100	0,082	1,57	2,94
	425	0,133	0,108	2,00	3,77
525	75	0,024	0,019	0,64	1,09
	125	0,043	0,035	0,86	1,55
	225	0,084	0,068	1,38	2,57
	325	0,125	0,102	1,90	3,59
	425	0,166	0,135	2,42	4,61
	525	0,207	0,168	2,94	5,63
625	75	0,029	0,023	0,75	1,28
	125	0,052	0,042	1,01	1,83
	225	0,101	0,082	1,62	3,03
	325	0,150	0,122	2,23	4,24
	425	0,199	0,162	2,85	5,44
	525	0,248	0,201	3,46	6,65
825	75	0,038	0,031	0,98	1,68
	125	0,069	0,056	1,31	2,39
	225	0,134	0,109	2,10	3,96
	325	0,200	0,162	2,90	5,54
	425	0,265	0,215	3,70	7,11
	525	0,330	0,268	4,50	8,69
1025	75	0,048	0,039	1,21	2,07
	125	0,086	0,070	1,61	2,95
	225	0,168	0,136	2,59	4,90
	325	0,249	0,202	3,57	6,84
	425	0,331	0,268	4,56	8,78
	525	0,412	0,334	5,54	10,73
1225	75	0,057	0,046	1,43	2,47
	125	0,104	0,084	1,90	3,51
	225	0,201	0,163	3,07	5,83
	325	0,299	0,242	4,24	8,14
	425	0,396	0,321	5,41	10,45
	525	0,494	0,401	6,58	12,77

A_{v1}, m₁, ...NOVA-B-1 - single-row
 A_{v2}, m₂, ...NOVA-B-2 - double-row

Tab. 2: Dimensions, free area and weight of the NOVA-B diffusion grilles

NOVA-L

An Aluminium Grille with Fixed Blades

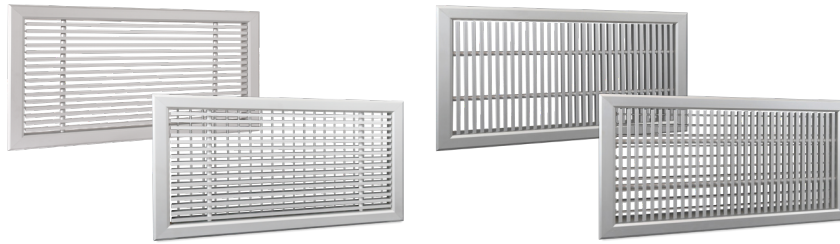

NOVA-L

Ordering Codes

Grille with horizontally aligned blades, single layer

		NOVA-L1-	□	□	□	□	□	□	□
Mounting	screws	1							
	spring clips ¹	2							
	safety mounting mechanism ¹	3							
Dimensions (structural opening)	L × H								
Damper R1	R								
Blade shaping type		1							
		2							
		4							
Blades' axial pitch (mm)		12							
		17							
		20							
Product version	standard	0							
	corner	C							
	middle	M							
Surface finish	anodized	AN							
	white (RAL9003)	SW							
	other RAL color	RAL							

See notes and ordering codes examples on next page.

Grille with horizontally aligned blades, double layer

		NOVA-L2-	□	□	□	□	□	□	□
Mounting	screws	1							
	spring clips	2							
	safety mounting mechanism	3							
Dimensions (structural opening)	L × H								
Damper R1	R								
Blade shaping type		1							
		2							
		4							
Blades' axial pitch (mm)		12							
		17							
		20							
Product version	standard	0							
	corner	C							
	middle	M							
Surface finish	anodized	AN							
	white (RAL9003)	SW							
	other RAL color	RAL							

See notes and ordering codes examples on next page.

Grille with vertically aligned blades, single layer

		NOVA-LV-	
Mounting	screws	1	
	spring clips ¹	2	
	safety mounting mechanism ¹	3	
Dimensions (structural opening)		L × H	
Damper R1		R	
Blade shaping type		1	
		2	
		4	
Blades' axial pitch (mm)		12	
		17	
		20	
Product version	standard	0	
Surface finish	anodized	AN	
	white (RAL9003)	SW	
	other RAL color	RAL	

Ordering code examples:

NOVA - LV - 1 - 600 × 100 - R - 2 - 12 - 0 - AN

A single layer bladed aluminium wall grille mounted with screws through a viewing frame, intended for a structural opening with dimensions 600 × 100 mm, type 1 blades with axial pitch 12 mm, standard version. Anodized surface finish.

NOVA - L2 - 2 - 600 × 200 - 2 - 17 - 0 - RAL

A double layer bladed aluminium wall grille mounted with spring clips, intended for a structural opening with dimensions 600 × 200 mm, type 2 blades face layer horizontally oriented with axial pitch 17 mm, standard version. RAL color surface finish (the RAL code of the surface color shall be noted in the remarks of the order).

- Delivered with mounting frame as standard for the mounting type 3.
- The mounting frame is not automatically included in a standard order for mounting type "1", if interested, please remember to order mounting frame UR.
- 3 types of blades (1, 2, 4) are available upon request (please see Fig. 8). In case the blade shaping type, alignment and axial pitch is not specified in the ordering code, type "1" blades with a horizontal alignment (NOVA-L1) and axial pitch 12 mm will be delivered as default. For NOVA-L1 and NOVA-LV the corner (type C) grille, the right- or left-sided orientation of blades type 2 shall be defined as note in the order. This secures the proper alignment of blades with middle (M-type) grilles.
 - It is only possible to choose blade type "4" with axial pitch 20.0 mm for the second row of the grille.
- In case the corner (C) or middle (M) grille version is not specified in the ordering code, the standard version of the product (0) will be delivered as default (it is not needed to enter it in the ordering code).
- In case the RAL surface finish is not specified in the ordering code, the product will be delivered with a natural eloxal surface finish as default. If a RAL color different from RAL9003 is required, then „RAL“ shall be written in the ordering code. The exact color definition - the RAL number - shall be stated in the notes of the order.
- NOVA-LV is available with the dimension L of max. 1225 mm

Description

NOVA-L is a rectangular aluminium grille with one or two rows of blades. The first row is always fixed, the second is adjustable. The NOVA-L grille is adequate for usage in such premises that require a higher emphasis on appearance and is designed for air supply and air extract. If needed, the grille can be split into several parts and installed in a continuous line of linear grilles. For a balanced distribution of air through the entire grille it is recommended to use a damper or a plenum box.

Information about the NOVA-L accessories is available from page 25.

- UR-NOVA - mounting frame (required for mounting types 2, 3)
- R1-NOVA - damper
- ODEN - plenum box
- PB-NOVA - plenum box

Mounting

The NOVA-L grille can be mounted directly onto a rectangular duct using countersunk screws (type "1" mounting), onto a wall using a mounting frame and spring clips (type "2" mounting + UR) or, if appropriate, it can also be placed onto a wall and a ceiling using a mounting frame and a safety mounting mechanism (type "3" mounting).

The type "3" safety mounting mechanism consists of a ratchet/spring combination which enables the fixing of the grille by sliding it into the mounting frame with no tools required. To detach the grille from the frame the ratchet springs shall be one by one pressed by a flat screwdriver towards the grille body pulling the grille out of the frame.

IMPORTANT: For fixing type "3" the size of the installation opening for the mounting frame must be exactly according to the specification in this document (H x L dimension in the dimensions table). The mounting frame after installation must not be deformed by external forces (like by mounting into improperly formed and sized installation opening, etc.) For sufficient safety the grilles with more than 4 fixing type "3" spring ratchets (dimension L of 600 mm or larger) are equipped by 2 chains. These must be fixed to the adjacent rigid building structure.

Design

Material used:

The NOVA-L grille is manufactured from aluminium profiles with eloxal coating or, if appropriate, a powder-lacquered (RAL 9003 - signal white) surface finish; other RAL types are available upon request. The operation temperature range is -20 to 100°C

Type of blades:

Single-row grilles can have both horizontal (Type L1) and vertical (Type LV) front blade alignment. The double layer bladed Nova grille (Type L2) has the face layer always horizontally aligned. The second layer of blades is always perpendicular to the face layer. The front blades' shape and axial pitch is optional, please see Fig. 8 or ordering codes. The second row blades are always type "4" with an axial pitch 20 mm.

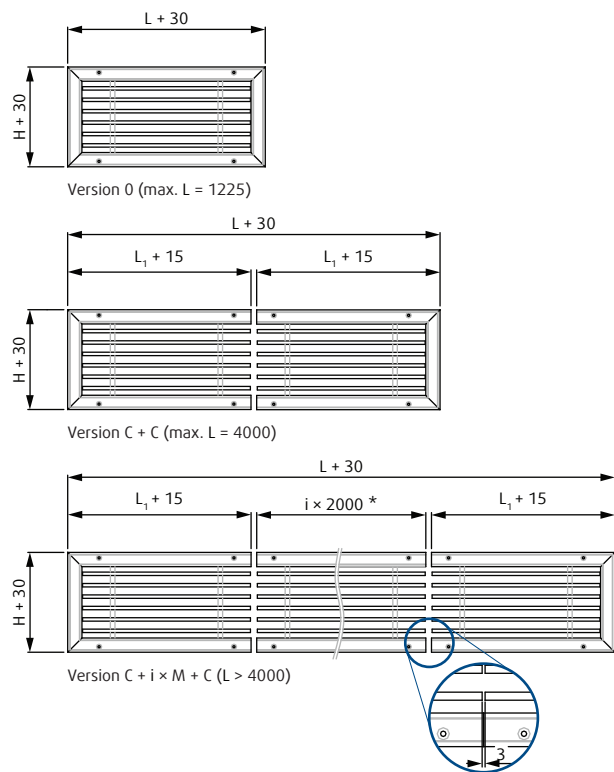

L_1 : Modulus length according to Table 9

$$(L_1 = (L - i \times 2000^*) / 2)$$

* Applicable only for blade type "1"; for blade types "2" and "4" use $i \times 1000$; for double-row with blade type "1" including a damper use $i \times 1225$

Fig. 3: Grille types based on their length

Coefficient K_{Av} and K_m

A free area correction coefficient for various types of axial pitch and blade types: $A_x = A_v \times K_{Av}$

$$m_x = m_1 \times K_m$$

No. of rows	Blades' axial pitch	Blade type	Correction factor K_{Av}	Correction factor K_m
1	12	1	See Table 9	See Table 9
		2		0,94
		4		0,84
	17	1	1,24	0,78
		2	1,63	0,74
		4	1,46	0,67
	20	1	1,34	0,73
		2	1,67	0,69
		4	1,53	0,63
2	12	1	0,47	See Table 9
		2	1,12	0,96
		4	0,85	0,89
	17	1	0,76	0,85
		2	1,22	0,82
		4	1,03	0,77
	20	1	0,88	0,82
		2	1,27	0,79
		4	1,10	0,75

Tab. 8: Free area calculation for various blade types and axial pitch

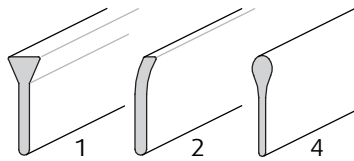
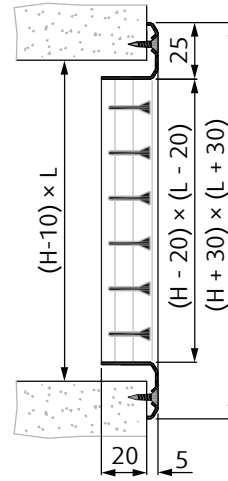
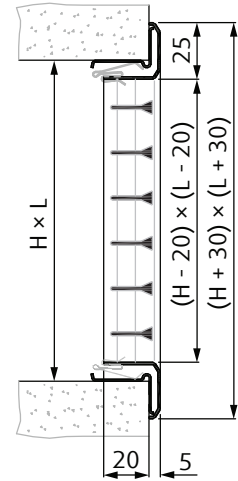

Fig. 4: Blades' shaping types



NOVA-L-1-1-LxH



NOVA-L-1-2-LxH-UR

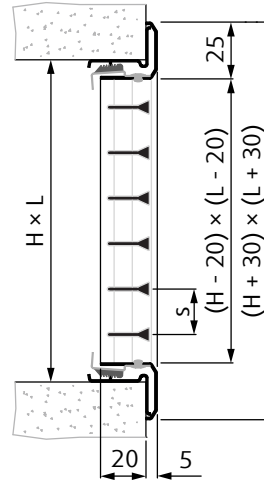

NOVA-L-1-3-LxH

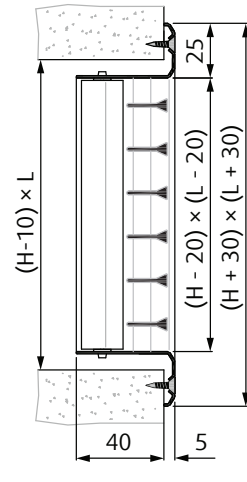

NOVA-L-2-1-LxH

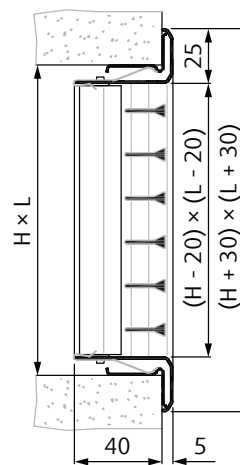

NOVA-L-2-2-LxH-UR

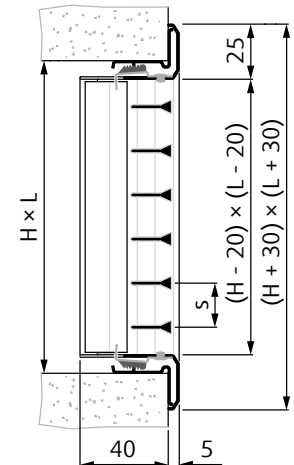





NOVA-L-2-3-LxH

Fig. 5: Basic NOVA-L dimensions and grille types

*** IMPORTANT: for installation and security information to the safety mounting mechanism „3“ see the article „Mounting“.**

Technical Details





Dimensions

Blades' axial pitch		12 mm							
Blade type		1 		2 		4 		1 	
Dimensions		Free area						Weight	
L	H	A _v	A _{v2}	A _v	A _{v2}	A _v	A _{v2}	m	m ₂
(mm)		(m ²)						(kg)	
200	100	0,007	0,003	0,011	0,008	0,010	0,006	0,26	0,36
	150	0,012	0,005	0,018	0,013	0,015	0,009	0,37	0,52
	200	0,016	0,007	0,025	0,017	0,021	0,013	0,48	0,67
300	100	0,012	0,006	0,018	0,013	0,015	0,010	0,37	0,52
	150	0,019	0,009	0,029	0,021	0,024	0,016	0,52	0,75
	200	0,026	0,012	0,040	0,028	0,034	0,021	0,68	0,97
300	300	0,039	0,017	0,061	0,044	0,052	0,033	0,99	1,43
	100	0,016	0,008	0,024	0,018	0,021	0,014	0,47	0,67
	150	0,026	0,012	0,039	0,028	0,034	0,022	0,68	0,97
400	200	0,035	0,016	0,054	0,039	0,046	0,030	0,88	1,27
	300	0,054	0,024	0,084	0,061	0,072	0,045	1,29	1,87
	400	0,073	0,033	0,115	0,082	0,097	0,061	1,69	2,46
500	100	0,021	0,010	0,031	0,023	0,027	0,017	0,58	0,83
	150	0,033	0,015	0,050	0,036	0,043	0,028	0,83	1,20
	200	0,045	0,021	0,069	0,050	0,059	0,038	1,08	1,57
	300	0,069	0,031	0,108	0,078	0,091	0,058	1,58	2,31
	400	0,093	0,042	0,146	0,105	0,124	0,079	2,09	3,05
500	500	0,117	0,053	0,184	0,133	0,156	0,099	2,59	3,79
	100	0,025	0,012	0,037	0,027	0,032	0,021	0,69	0,99
	150	0,039	0,018	0,060	0,043	0,051	0,033	0,99	1,43
	200	0,054	0,025	0,083	0,060	0,071	0,045	1,29	1,88
	300	0,083	0,037	0,129	0,093	0,109	0,069	1,89	2,76
600	400	0,112	0,050	0,175	0,126	0,148	0,094	2,50	3,65
	500	0,141	0,063	0,221	0,159	0,187	0,118	3,10	4,54
	100	0,033	0,016	0,051	0,037	0,043	0,028	0,90	1,30
	150	0,053	0,025	0,082	0,059	0,070	0,045	1,30	1,88
	200	0,073	0,034	0,113	0,082	0,096	0,062	1,69	2,47
800	300	0,112	0,051	0,175	0,127	0,149	0,095	2,49	3,65
	400	0,152	0,069	0,238	0,172	0,201	0,128	3,28	4,82
	500	0,191	0,086	0,300	0,216	0,254	0,162	4,08	5,99
	100	0,042	0,020	0,064	0,046	0,054	0,035	1,11	1,61
	150	0,067	0,031	0,103	0,074	0,087	0,056	1,61	2,34
1000	200	0,091	0,042	0,142	0,102	0,120	0,077	2,11	3,08
	300	0,141	0,064	0,220	0,159	0,187	0,119	3,10	4,54
	400	0,190	0,086	0,298	0,215	0,253	0,161	4,09	6,01
	500	0,240	0,108	0,376	0,271	0,319	0,202	5,08	7,47
	100	0,051	0,025	0,077	0,056	0,066	0,043	1,33	1,92
1200	150	0,081	0,038	0,124	0,090	0,106	0,068	1,92	2,80
	200	0,111	0,051	0,172	0,124	0,146	0,094	2,51	3,67
	300	0,170	0,078	0,266	0,193	0,226	0,144	3,69	5,42
	400	0,230	0,105	0,361	0,261	0,306	0,195	4,88	7,17
	500	0,290	0,131	0,455	0,329	0,386	0,246	6,06	8,93

A_{v1}, m₁, ...NOVA-L1 (LV) - single-row

A_{v2}, m₂, ...NOVA-L2 - double-row

Tab. 9 - part 1: Dimensions, free area and weight of the NOVA-L grilles

Blades' axial pitch		12 mm							
Blade type		1 		2 		4 		1 	
Dimensions		Free area						Weight	
L	H	A _v	A _{v2}	A _v	A _{v2}	A _v	A _{v2}	m	m ₂
(mm)		(m ²)						(kg)	
225	75	0,006	0,003	0,009	0,006	0,008	0,005	0,23	0,31
	125	0,011	0,005	0,017	0,012	0,014	0,009	0,35	0,49
	225	0,021	0,009	0,032	0,023	0,027	0,017	0,59	0,83
325	75	0,009	0,005	0,013	0,010	0,012	0,008	0,31	0,43
	125	0,017	0,008	0,025	0,018	0,022	0,014	0,48	0,68
	225	0,032	0,015	0,049	0,036	0,042	0,027	0,81	1,16
425	325	0,047	0,021	0,073	0,053	0,062	0,039	1,15	1,65
	75	0,012	0,006	0,018	0,013	0,016	0,01	0,39	0,55
	125	0,022	0,011	0,034	0,025	0,029	0,019	0,61	0,87
425	225	0,043	0,02	0,066	0,048	0,056	0,036	1,04	1,50
	325	0,063	0,029	0,098	0,071	0,083	0,053	1,47	2,13
	425	0,083	0,038	0,13	0,094	0,111	0,071	1,90	2,76
525	75	0,015	0,008	0,023	0,017	0,020	0,013	0,47	0,67
	125	0,028	0,014	0,043	0,031	0,037	0,024	0,74	1,06
	225	0,054	0,025	0,083	0,060	0,071	0,045	1,26	1,83
	325	0,079	0,036	0,124	0,090	0,105	0,067	1,79	2,61
525	425	0,105	0,048	0,164	0,119	0,139	0,089	2,32	3,38
	525	0,130	0,059	0,204	0,148	0,173	0,111	2,84	4,15
	75	0,018	0,009	0,027	0,02	0,023	0,015	0,56	0,79
	125	0,033	0,016	0,051	0,037	0,044	0,028	0,87	1,26
625	225	0,064	0,029	0,099	0,071	0,084	0,054	1,50	2,18
	325	0,094	0,043	0,147	0,106	0,125	0,079	2,13	3,10
	425	0,124	0,056	0,195	0,14	0,165	0,105	2,75	4,02
	525	0,155	0,07	0,243	0,175	0,206	0,131	3,38	4,94
825	75	0,024	0,012	0,036	0,027	0,031	0,021	0,72	1,03
	125	0,045	0,021	0,068	0,050	0,058	0,038	1,13	1,64
	225	0,085	0,040	0,133	0,096	0,113	0,072	1,95	2,84
	325	0,126	0,058	0,197	0,143	0,167	0,107	2,77	4,05
	425	0,167	0,076	0,262	0,189	0,222	0,142	3,59	5,26
825	525	0,208	0,094	0,326	0,236	0,276	0,176	4,41	6,47
	75	0,03	0,015	0,045	0,033	0,039	0,026	0,89	1,27
	125	0,056	0,027	0,085	0,062	0,073	0,047	1,39	2,02
	225	0,106	0,049	0,165	0,12	0,141	0,09	2,41	3,52
	325	0,157	0,072	0,246	0,178	0,208	0,133	3,43	5,02
1025	425	0,208	0,094	0,326	0,236	0,276	0,176	4,44	6,52
	525	0,258	0,117	0,406	0,293	0,344	0,219	5,46	8,02
	75	0,037	0,019	0,054	0,040	0,047	0,031	1,05	1,51
1225	125	0,067	0,032	0,103	0,075	0,088	0,057	1,65	2,41
	225	0,128	0,060	0,199	0,145	0,169	0,109	2,86	4,19
	325	0,189	0,087	0,296	0,215	0,251	0,161	4,07	5,97
	425	0,250	0,114	0,393	0,284	0,333	0,213	5,28	7,76
	525	0,311	0,142	0,489	0,354	0,415	0,265	6,49	9,54

A_{v1}, m₁, ...NOVA-L1 (LV) - single-row

A_{v2}, m₂, ...NOVA-L2 - double-row

Tab. 9 - part 2: Dimensions, free area and weight of the NOVA-L grilles

NOVA-S

An Aluminium Window Sill Grille



Ordering Code

Dimensions	L × H	NOVA-S-				
Support frame UR3 ¹	UR3					
Blade shaping type ²	1 2 4					
Blades' axial pitch ³	12 17 20					
Surface finish ⁴	anodized RAL9003 other RAL color	AN SW RAL				

Ordering code example:

NOVA-S - 500 × 100 - UR3 - 1 - 17

An aluminium window sill grille with nominal dimensions 500 × 100 mm, with a support frame for mounting, type 1 blades with axial pitch 17 mm.

1. The NOVA-S grille is not fixed to the UR3. It is held in horizontal position by gravity.
2. 3 types of blades are available upon request (please see Fig. 8).
3. In case the blade shaping type and axial pitch is not specified in the ordering code, type "1" blades with an axial pitch of 12 mm will be delivered as default.
4. In case the RAL surface finish is not specified in the ordering code, the product will be delivered with a natural eloxal surface finish as default. If a RAL color different from RAL9003 is required, then „RAL“ shall be written in the ordering code. The exact color definition - the RAL number - shall be stated in the notes of the order.

Description

NOVA-S is a rectangular aluminium grille with one row of fixed blades. It is adequate for usage in such premises that require a higher emphasis on appearance and is designed for air supply and air extract.

Accessories:

- UR3-NOVA - support frame

Mounting

The NOVA-S grille can be mounted into a window sill opening using the support frame (UR3-NOVA) for simple-to-clean and demountable installations onto window sills, or individually.

Design

Material used: The NOVA-S grille is manufactured from aluminium profiles with eloxal coating or, if appropriate, a powder-lacquered (RAL 9003 - signal white) surface finish; other RAL types are available upon request.

Type of blades: The grille's blades have a horizontal alignment. Their shape and axial pitch is optional, please see Fig. 8 or the ordering codes.

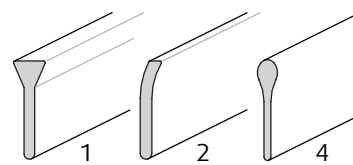

Fig. 6: Blades' shaping types

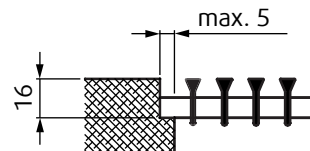

Fig. 7: The NOVA-S grille mounting directly into a window sill opening

Coefficient K_{Av} a K_m

A free area and weight correction coefficient for various types of axial pitch and blade types: $A_x = A_v \times K_{Av}$

$$m_x = m_1 \times K_m$$

Blades' axial pitch	Blade type	Correction factor	
		K_{Av}	K_m
12	1	* See Table 11	* See Table 11
	2		0,94
	4		0,84
17	1	1,24	0,78
	2	1,63	0,74
	4	1,46	0,67
20	1	1,34	0,73
	2	1,67	0,69
	4	1,53	0,63

Tab. 10: Free area calculation for various blade types and axial pitch

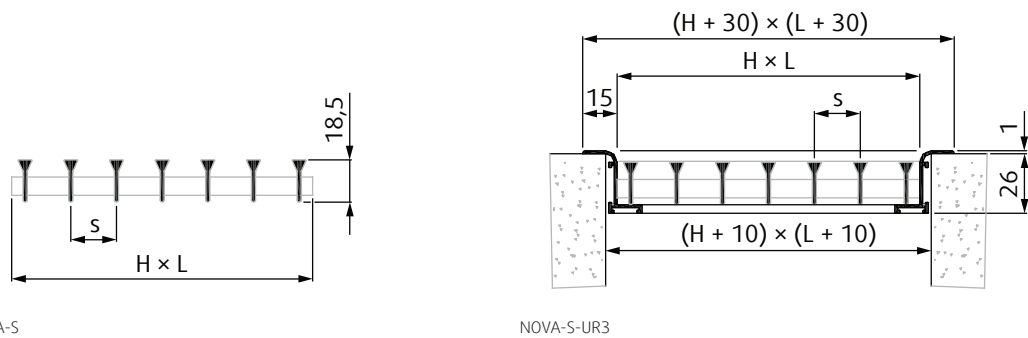



Fig. 8: Basic NOVA-S dimensions and grille types

Technical Details

Dimensions

Blades' axial pitch		12 mm						UR3
Blade type		1		2		4		
Dimensions		Free area	Weight	Free area	Weight	Free area	Weight	
L	H	A _v	m	A _v	m	A _v	m	
(mm)		(m ²)	(kg)	(m ²)	(kg)	m ²	(kg)	
200	100	0,006	0,17	0,010	0,16	0,008	0,13	0,13
	150	0,010	0,27	0,017	0,25	0,014	0,21	0,15
	200	0,014	0,36	0,024	0,33	0,020	0,29	0,17
300	100	0,010	0,25	0,017	0,23	0,014	0,20	0,17
	150	0,016	0,40	0,028	0,37	0,023	0,32	0,19
	200	0,023	0,54	0,038	0,50	0,032	0,43	0,21
	300	0,036	0,83	0,060	0,77	0,050	0,66	0,26
400	100	0,013	0,34	0,023	0,31	0,019	0,27	0,21
	150	0,023	0,53	0,038	0,49	0,032	0,42	0,24
	200	0,032	0,72	0,053	0,66	0,044	0,57	0,26
	300	0,050	1,11	0,083	1,02	0,069	0,88	0,30
	400	0,069	1,49	0,113	1,37	0,094	1,18	0,34
500	100	0,017	0,42	0,030	0,39	0,024	0,33	0,26
	150	0,029	0,66	0,049	0,61	0,040	0,52	0,28
	200	0,041	0,90	0,068	0,83	0,056	0,71	0,30
	300	0,065	1,38	0,106	1,27	0,088	1,09	0,34
	400	0,088	1,87	0,144	1,71	0,120	1,47	0,39
	500	0,112	2,35	0,182	2,16	0,152	1,85	0,43
600	100	0,021	0,51	0,036	0,47	0,029	0,40	0,30
	150	0,035	0,80	0,058	0,74	0,048	0,63	0,32
	200	0,049	1,09	0,081	1,01	0,068	0,86	0,34
	300	0,077	1,68	0,127	1,54	0,106	1,32	0,39
	400	0,106	2,26	0,173	2,08	0,145	1,79	0,43
	500	0,134	2,84	0,218	2,61	0,183	2,25	0,47
800	100	0,028	0,68	0,048	0,62	0,040	0,53	0,39
	150	0,048	1,07	0,080	0,98	0,066	0,84	0,41
	200	0,067	1,45	0,111	1,34	0,092	1,15	0,43
	300	0,106	2,23	0,173	2,05	0,145	1,76	0,47
	400	0,145	3,00	0,235	2,76	0,197	2,37	0,51
	500	0,184	3,78	0,297	3,47	0,249	2,98	0,56
1000	100	0,035	0,85	0,061	0,78	0,050	0,67	0,47
	150	0,060	1,34	0,100	1,23	0,083	1,06	0,49
	200	0,084	1,83	0,139	1,68	0,116	1,44	0,51
	300	0,133	2,80	0,217	2,57	0,182	2,21	0,56
	400	0,182	3,77	0,295	3,46	0,247	2,97	0,60
	500	0,231	4,74	0,373	4,36	0,313	3,74	0,64
1200	100	0,043	1,02	0,074	0,94	0,061	0,80	0,56
	150	0,073	1,60	0,121	1,47	0,101	1,26	0,58
	200	0,102	2,19	0,168	2,01	0,140	1,72	0,60
	300	0,161	3,35	0,263	3,08	0,220	2,64	0,64
	400	0,221	4,52	0,357	4,15	0,300	3,56	0,68
	500	0,280	5,68	0,451	5,22	0,379	4,47	0,73

Tab. 11: Dimensions, free area and weight of the NOVA-S grilles

NOVA-R

An Aluminium Non-Transparent Grille

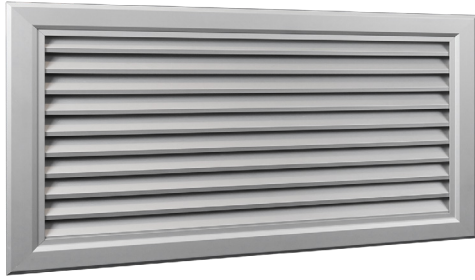

Description

NOVA-R is a rectangular non-transparent aluminium grille with fixed blades. It is adequate for usage in such premises that require a higher emphasis on appearance and is designed for air extract. If the grille is equipped with a protective mesh screen, it can also be installed on the exterior building wall as a grille for air supply. For a balanced distribution of air through the entire grille it is recommended to use a damper or a plenum box.

Ordering Code

		NOVA-R-	□	□	□	□	□	□
Mounting	screws	1						
	spring clips ¹	2						
Dimensions		L × H						
Damper		R1						
Mounting frame ¹		UR						
Mesh screen	galvanized wire	S						
Surface finish ²	anodized	AN						
	RAL9003	SW						
	other RAL color	RAL						

Information about the NOVA-R accessories is available from page 25.

- R1-NOVA – damper
- UR-NOVA – mounting frame
- S – mesh screen with 10 x 10 mm openings
- ODEN – plenum box
- PB-NOVA – plenum box

Mounting

The NOVA-R grille can be mounted directly onto a rectangular duct using countersunk screws (type "1" mounting), or onto a wall using a mounting frame and spring clips (type "2" mounting).

Ordering code example:

NOVA-R - 2 - 325 × 125 - UR - S - AN

An aluminium non-transparent grille with mounting with spring clips, intended for a structural opening with dimensions 325 × 125 mm, with a mounting frame and a protective mesh screen with 10 × 10 mm openings.

1. The mounting frame is not automatically included in a standard order, if interested in type "2" mounting using spring clips, please remember to add the "UR" option into the ordering code.
2. In case the RAL surface finish is not specified in the ordering code, the product will be delivered with a natural eloxal surface finish as default. If a RAL color different from RAL9003 is required, then „RAL" shall be written in the ordering code. The exact color definition - the RAL number - shall be stated in the notes of the order.

Design

Material used:

The NOVA-R grille is manufactured from aluminium profiles with eloxal coating or, if appropriate, a powder-lacquered (RAL 9003 - signal white) surface finish; other RAL types are available upon request.

The optional mesh screen is manufactured from galvanized wire with 10 × 10 mm nooses. Upon request, it can be manufactured from stainless steel. The operation temperature range is -20 to 100°C

Type of blades:

The grille's blades are fixed with an axial pitch 20 mm, inclined downwards in a 45° angle.

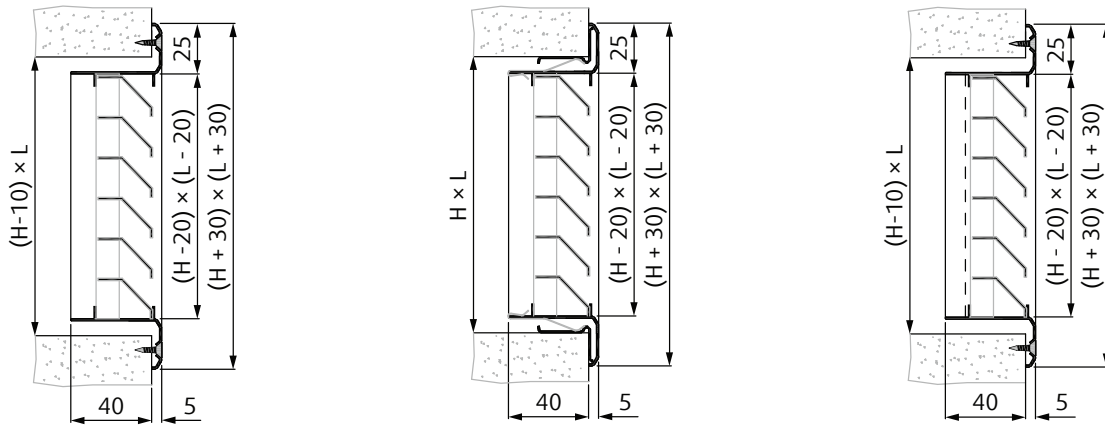

NOVA-R-1-LxH

NOVA-R-2-LxH-UR

NOVA-R-1-LxH-S

Fig. 9: Basic NOVA-R dimensions and grille types

Technical Details

Dimensions

Dimensions		Free area	Weight
L	H	A _v	m
(mm)		(m ²)	(kg)
200	100	0,005	0,28
	150	0,008	0,37
	200	0,012	0,48
300	100	0,008	0,38
	150	0,013	0,49
	200	0,020	0,63
	300	0,033	0,88
400	100	0,011	0,47
	150	0,018	0,60
	200	0,029	0,78
	300	0,047	1,10
500	400	0,064	1,42
	100	0,014	0,56
	150	0,023	0,72
	200	0,037	0,94
	300	0,060	1,32
600	400	0,083	1,70
	500	0,106	2,08
	100	0,017	0,65
	150	0,028	0,83
	200	0,045	1,09
800	300	0,073	1,53
	400	0,102	1,97
	500	0,130	2,42
	100	0,023	0,84
	150	0,038	1,08
1000	200	0,061	1,42
	300	0,099	2,00
	400	0,137	2,58
	500	0,175	3,16
	1200	100	0,029
150		0,048	1,32
200		0,077	1,73
300		0,126	2,44
400		0,174	3,14
1200	500	0,222	3,85
	100	0,035	1,21
	150	0,059	1,55
	200	0,094	2,04
	300	0,152	2,87
1200	400	0,211	3,70
	500	0,270	4,53

Dimensions		Free area	Weight
L	H	A _v	m
(mm)		(m ²)	(kg)
225	125	0,007	0,35
	225	0,016	0,56
325	125	0,011	0,46
	225	0,025	0,73
	325	0,039	1,00
425	125	0,015	0,56
	225	0,035	0,89
	325	0,054	1,23
525	425	0,073	1,56
	125	0,019	0,66
	225	0,044	1,06
	325	0,068	1,45
625	425	0,093	1,85
	525	0,117	2,24
	125	0,024	0,77
	225	0,053	1,22
825	325	0,083	1,68
	425	0,112	2,14
	525	0,142	2,60
	125	0,031	0,99
1025	225	0,071	1,59
	325	0,110	2,18
	425	0,149	2,78
	525	0,188	3,37
	125	0,040	1,20
1225	225	0,089	1,92
	325	0,139	2,64
	425	0,188	3,36
	525	0,238	4,08
	125	0,048	1,41
1225	225	0,108	2,25
	325	0,168	3,10
	425	0,228	3,94
	525	0,288	4,79

Tab. 13: Dimensions, free area and weight of the NOVA-R grilles

NOVA-E

An Aluminium Grille with Square Openings

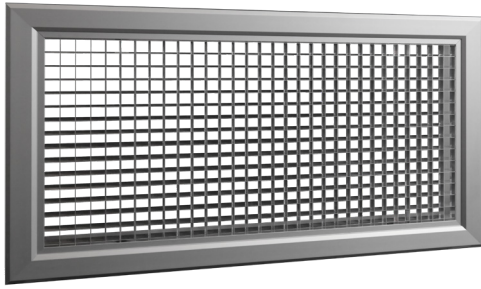

Description

NOVA-E is a rectangular aluminium grille with a large free area (up to 90%). It is adequate for usage in such premises that require a higher emphasis on appearance and is designed for air supply and air extract. For a balanced distribution of air through the entire grille it is recommended to use a damper or a plenum box.

Information about the NOVA-E accessories is available from page 25.

- R1-NOVA - damper
- UR-NOVA - mounting frame

Ordering Code

Mounting	screws spring clips ¹	NOVA-E- 1 2	
Dimensions		L × H	
Damper		R1	
Mounting frame		UR	
Surface finish ²	anodized RAL9003 other RAL color	AN SW RAL	

Ordering code example:

NOVA-E - 1 - 800 × 100 - R1 - AN

An aluminium grille with a large free area and mounting with screws through a viewing frame, intended for a structural opening with dimensions 800 × 100 mm, R1-NOVA damper.

1. The mounting frame is not automatically included in a standard order, if interested in type "2" mounting using spring clips, please remember to add the "UR" option into the ordering code.
2. In case the RAL surface finish is not specified in the ordering code, the product will be delivered with a natural eloxal surface finish as default. If a RAL color different from RAL9003 is required, then „RAL“ shall be written ordering code. The exact color definition - the RAL number - shall be stated in the notes of the order.

Mounting

The NOVA-E grille can be mounted directly onto a duct using countersunk screws (type "1" mounting), or onto a wall using a mounting frame and spring clips (type "2" mounting).

Design

Material used:

The NOVA-E grille is manufactured from aluminium profiles with eloxal coating or, if appropriate, a powder-lacquered (RAL 9003 - signal white) surface finish; other RAL types are available upon request.

The inside of NOVA-E is formed by a grating (with the openings' dimensions being 12.7 × 12.7 mm), manufactured from an aluminium sheet with either no surface finish or a powder-lacquered surface finish. The operation temperature range is -20 to 100°C

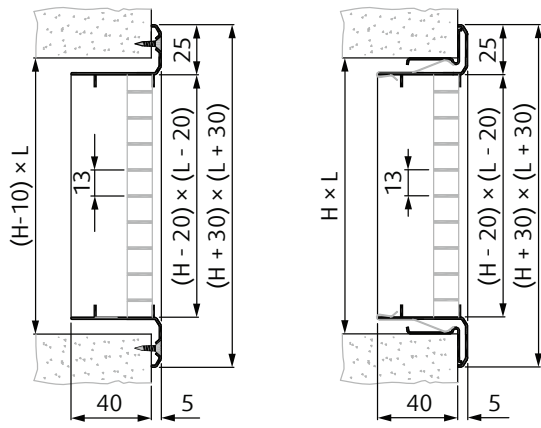

NOVA-E-1-LxH

NOVA-E-2-LxH-UR

Fig. 10: Basic NOVA-E dimensions and grille types

Technical Details

Dimensions

Dimensions		Free area	Weight
L	H	A _v	m
(mm)		(m ²)	(kg)
225	125	0,017	0,28
	225	0,036	0,38
325	125	0,026	0,36
	225	0,054	0,49
	325	0,082	0,61
425	125	0,035	0,44
	225	0,072	0,59
	325	0,109	0,74
	425	0,146	0,88
525	125	0,044	0,52
	225	0,090	0,69
	325	0,137	0,86
	425	0,183	1,03
625	525	0,230	1,21
	125	0,053	0,59
	225	0,109	0,79
	325	0,164	0,99
	425	0,220	1,18
825	525	0,276	1,38
	125	0,071	0,75
	225	0,145	0,99
	325	0,220	1,23
	425	0,294	1,48
1025	525	0,369	1,72
	125	0,089	0,90
	225	0,182	1,19
	325	0,275	1,48
	425	0,368	1,78
1225	525	0,461	2,07
	125	0,106	1,06
	225	0,218	1,40
	325	0,330	1,73
	425	0,442	2,07
563*	563*	0,262	1,36

Dimensions		Free area	Weight
L	H	A _v	m
(mm)		(m ²)	(kg)
200	100	0,013	0,24
	150	0,022	0,29
	200	0,030	0,34
300	100	0,021	0,31
	150	0,034	0,37
	200	0,047	0,43
	300	0,073	0,55
400	100	0,028	0,38
	150	0,046	0,45
	200	0,064	0,53
	300	0,100	0,67
	400	0,135	0,81
500	100	0,036	0,45
	150	0,058	0,54
	200	0,081	0,62
	300	0,126	0,79
	400	0,171	0,95
	500	0,216	1,12
600	100	0,043	0,53
	150	0,071	0,62
	200	0,098	0,72
	300	0,152	0,91
	400	0,207	1,10
	500	0,261	1,29
800	100	0,058	0,67
	150	0,095	0,79
	200	0,132	0,91
	300	0,205	1,14
	400	0,278	1,38
	500	0,351	1,62
1000	100	0,073	0,81
	150	0,119	0,95
	200	0,165	1,10
	300	0,257	1,38
	400	0,349	1,67
1200	500	0,441	1,95
	100	0,088	0,95
	150	0,144	1,12
	200	0,199	1,29
	300	0,310	1,62
	400	0,420	1,95
	500	0,531	2,29

* Dimension for a suspended grid ceiling 600 × 600 mm

Tab. 15: Dimensions, free area and weight of the NOVA-E grilles

NOVA-D

An Aluminium Door Grille



Description

NOVA-D is a rectangular non-transparent aluminium grille with fixed blades. It is adequate for usage in such premises that require a higher emphasis on appearance and is designed for a free air flow through both sides of the grille.

Mounting

The NOVA-D grille can be mounted into the door using countersunk screws (type "1" mounting), or it can be supplied without pre-drilled holes for fixing using glue. It is possible to choose from two types of mounting frames for a more narrow (UR1) or a wider (UR2) door (please see Fig. 17).

Design

Material used:

The NOVA-D grille is manufactured from aluminium profiles with eloxal coating or, if appropriate, a powder-lacquered (RAL 9003 - signal white) surface finish; other RAL types are available upon request. The operation temperature range is -20 to 100°C

Ordering Code

		NOVA-D-	<input type="checkbox"/>	<input type="checkbox"/>	<input type="checkbox"/>
Fixing	screws	1			
	glue	2			
Dimensions		L × H			
Mounting frame	narrow	UR1			
	wide	UR2			
Surface finish ¹	anodized	AN			
	RAL9003	SW			
	other RAL color	RAL			

Ordering code example:

NOVA-D - 2 - 400 × 150 - UR1 - AN

An aluminium door grille with fixing to door using glue, intended for a structural opening with dimensions 400 × 150 mm, with a type 1 mounting frame.

- In case the RAL surface finish is not specified in the ordering code, the product will be delivered with a natural eloxal surface finish as default. If a RAL color different from RAL9003 is required, then „RAL“ shall be written in the ordering code. The exact color definition - the RAL number - shall be stated in the notes of the order.

Type of blades:

The grille's blades are fixed with an axial pitch 15 mm in the shape of an upturned letter "V". The blades overlap each other.

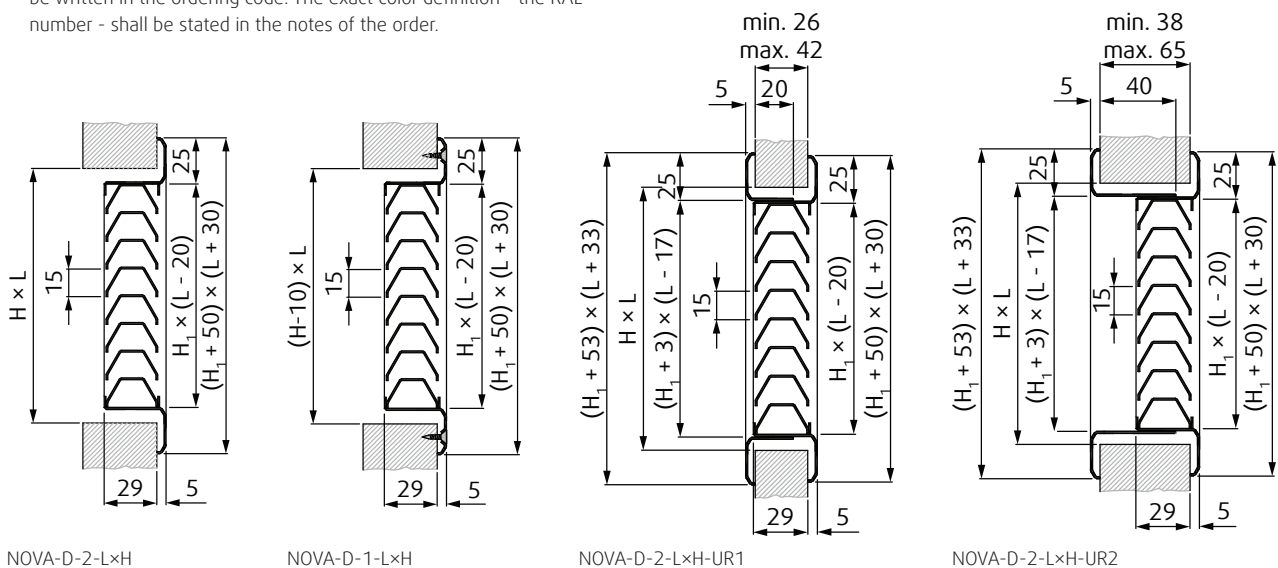

Fig. 11: Basic NOVA-D dimensions and grille types

Technical Details

Dimensions

Dimensions			Free area A_v	Weight		
L	H	H_1		m	UR1	UR2
(mm)			(m ²)	(kg)		
200	100	91	0,005	0,33	0,14	0,17
	150	136	0,007	0,43	0,15	0,19
	200	181	0,009	0,53	0,17	0,21
300	100	91	0,007	0,46	0,17	0,21
	150	136	0,011	0,60	0,18	0,23
	200	181	0,015	0,75	0,20	0,26
400	300	286	0,023	1,09	0,23	0,30
	100	91	0,010	0,58	0,20	0,30
	150	136	0,015	0,77	0,22	0,28
	200	181	0,020	0,96	0,23	0,30
500	300	286	0,032	1,40	0,27	0,35
	400	391	0,043	1,84	0,30	0,40
	100	91	0,013	0,71	0,24	0,31
	150	136	0,019	0,94	0,25	0,33
600	200	181	0,025	1,17	0,27	0,35
	300	286	0,040	1,71	0,30	0,39
	400	391	0,055	2,25	0,34	0,44
	500	491	0,070	2,78	0,37	0,49
800	100	91	0,015	0,84	0,27	0,35
	150	136	0,023	1,11	0,28	0,37
	200	181	0,031	1,38	0,30	0,39
	300	286	0,048	2,02	0,33	0,44
	400	391	0,066	2,66	0,37	0,49
1000	500	491	0,084	3,29	0,40	0,53
	100	91	0,021	1,10	0,34	0,44
	150	136	0,031	1,45	0,35	0,46
	200	181	0,041	1,81	0,37	0,48
	300	286	0,065	2,64	0,40	0,53
1200	400	391	0,089	3,48	0,44	0,58
	500	491	0,114	4,30	0,47	0,61
	100	91	0,026	1,35	0,40	0,53
	150	136	0,039	1,79	0,42	0,55
	200	181	0,052	2,24	0,43	0,57
1200	300	286	0,082	3,27	0,47	0,62
	400	391	0,113	4,30	0,50	0,67
	500	491	0,143	5,32	0,54	0,71
	100	91	0,031	1,61	0,47	0,62
	150	136	0,047	2,13	0,49	0,64
1200	200	181	0,063	2,66	0,50	0,66
	300	286	0,099	3,89	0,54	0,71
	400	391	0,136	5,12	0,57	0,76
	500	491	0,172	6,34	0,60	0,80

Dimensions			Free area A_v	Weight		
L	H	H_1		m	UR1	UR2
(mm)			(m ²)	(kg)		
225	125	116	0,007	0,43	0,15	0,19
	225	211	0,012	0,66	0,18	0,23
325	125	116	0,011	0,59	0,19	0,24
	225	211	0,019	0,90	0,22	0,28
	325	316	0,028	1,27	0,25	0,33
425	125	116	0,014	0,75	0,22	0,28
	225	211	0,025	1,14	0,25	0,33
	325	316	0,037	1,61	0,29	0,37
525	425	416	0,050	2,07	0,32	0,42
	125	116	0,018	0,90	0,25	0,33
	225	211	0,031	1,39	0,28	0,37
	325	316	0,047	1,95	0,32	0,42
625	425	416	0,062	2,50	0,35	0,46
	525	511	0,075	2,99	0,38	0,51
	125	116	0,021	1,06	0,29	0,37
	225	211	0,037	1,63	0,32	0,42
825	325	316	0,056	2,29	0,35	0,46
	425	416	0,075	2,94	0,39	0,51
	525	511	0,091	3,51	0,42	0,55
	125	116	0,028	1,37	0,35	0,46
1025	225	211	0,050	2,11	0,38	0,51
	325	316	0,075	2,97	0,42	0,56
	425	416	0,099	3,82	0,45	0,60
	525	511	0,121	4,56	0,49	0,64
	125	116	0,036	1,68	0,42	0,56
1225	225	211	0,062	2,59	0,45	0,6
	325	316	0,093	3,64	0,49	0,65
	425	416	0,124	4,70	0,52	0,69
	525	511	0,151	5,60	0,55	0,73
	125	116	0,043	1,99	0,49	0,65
1225	225	211	0,075	3,07	0,52	0,69
	325	316	0,112	4,32	0,55	0,74
	425	416	0,149	5,57	0,59	0,78
	525	511	0,181	6,65	0,62	0,83

Tab. 16: Dimensions, free area and weight of the NOVA-D grilles

Accessories

Damper for NOVA

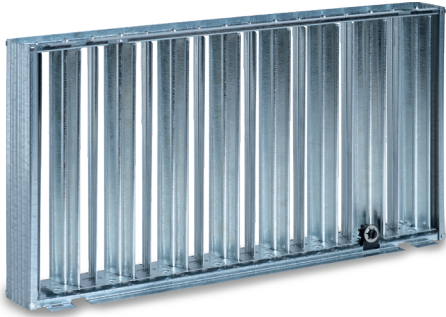

Ordering Code

Dimensions

R1-NOVA
L × H

Ordering code examples:

R1-NOVA - 1025 × 75

Damper for NOVA, dimensions 1025 × 75 mm.

Design

R1-NOVA is manufactured from galvanized steel sheet. The product consists of a frame, adjustable blades and a regulating wheel. The blades are opposed and interconnected. The blades angle controls the air flow. The product is provided without any additional surface finish.

Description

R1-NOVA is a damper for NOVA grilles. The product is intended to balance distribution of air through the entire grille.

The product is intended for air supply as well as for air extract. The damper changes the air flow using its regulating wheel. The regulating wheel is operated by a flap tip screwdriver.

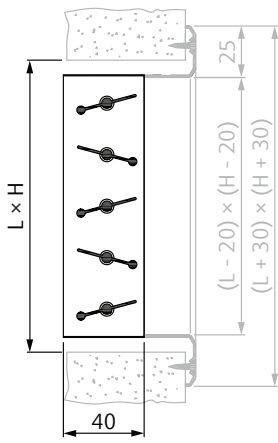

R1-NOVA

Fig. 12: The R1-NOVA damper dimensions

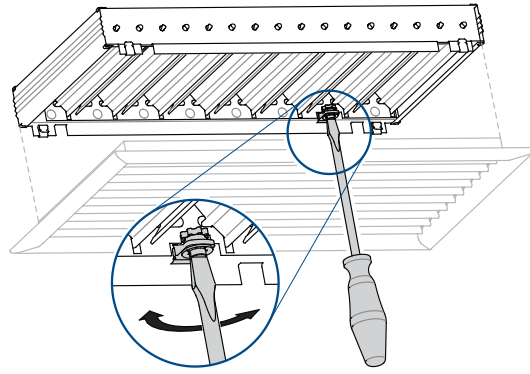

R1-NOVA

Fig. 13: Adjustment of the R1-NOVA damper

Technical Details

Dimensions

Dimensions		Weight	Dimensions		Weight
L	H		L	H	
(mm)		(kg)	(mm)		(kg)
200	100	0,36	225	75	0,32
	150	0,48		125	0,47
	200	0,61		225	0,75
300	100	0,53	325	75	0,46
	150	0,71		125	0,67
	200	0,90		225	1,06
	300	1,27		325	1,46
400	100	0,69	425	75	0,61
	150	0,93		125	0,87
	200	1,18		225	1,39
	300	1,67		325	1,90
	400	2,15		425	2,42
500	100	0,86	525	75	0,74
	150	1,15		125	1,07
	200	1,47		225	1,70
	300	2,07		325	2,33
	400	2,67		425	2,96
	500	3,29		525	3,61
600	100	1,03	625	75	0,88
	150	1,38		125	1,26
	200	1,75		225	2,01
	300	2,47		325	2,76
	400	3,19		425	3,50
	500	3,93		525	4,28
800	100	1,40	825	75	1,17
	150	1,86		125	1,68
	200	2,35		225	2,65
	300	3,30		325	3,63
	400	4,25		425	4,61
	500	5,23		525	5,62
1000	100	1,73	1025	75	1,45
	150	2,30		125	2,08
	200	2,92		225	3,29
	300	4,10		325	4,50
	400	5,28		425	5,71
	500	6,50		525	6,96
1200	100	2,08	1225	75	1,72
	150	2,76		125	2,47
	200	3,49		225	3,91
	300	4,91		325	5,36
	400	6,32		425	6,80
	500	7,78		525	8,29

Tab. 19: Dimensions and weight of the R1-NOVA damper

Mounting Frame for the NOVA Series

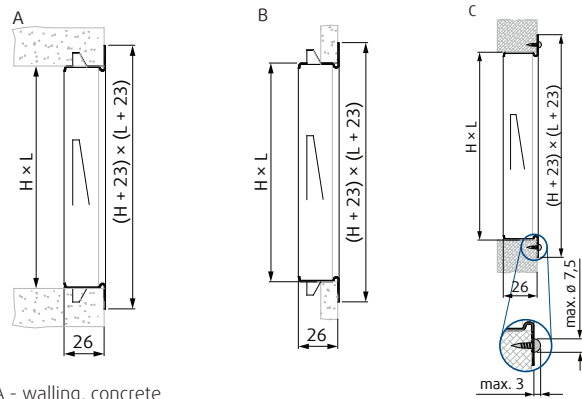

A - walling, concrete
 B - plaster board
 C - wood

Fig. 14: Mounting into various material types

Ordering Code

Dimensions	L x H	UR-NOVA-	
Material	stainless steel A304	A2	
	stainless steel A316	A4	
	galvanized steel	ZN	

Ordering code example:

UR - NOVA - 525 x 225 - A2

A mounting frame for the NOVA grilles intended for a structural opening with dimensions 325 x 225 mm from Stainless steel A304.

Description

UR-NOVA is a mounting frame, intended for a simplified installation of the NOVA series grilles into a wall, ceiling or a duct.

Mounting

The UR-NOVA mounting frame is designed for fixation to any NOVA grille, regardless of its mounting type. There are screw openings on its front to be able to mount the UR-NOVA into a solid surface. For mounting into a plaster board or mortar there are triangle-shaped lugs which can dodge in a requested angle during installation.

Design

The mounting frame is manufactured from a galvanized steel sheet. Stainless steel product version A2 or A4 is available upon request.

Dimensions		Weight	Dimensions		Weight
L	H	UR	L	H	UR
(mm)		(kg)	(mm)		(kg)
200	100	0,19	225	75	0,19
	150	0,22		125	0,22
	200	0,26		225	0,29
300	100	0,26	325	75	0,26
	150	0,29		125	0,29
	200	0,33		225	0,36
	300	0,39		325	0,43
400	100	0,33	425	75	0,33
	150	0,36		125	0,36
	200	0,39		225	0,43
	300	0,46		325	0,49
	400	0,53		425	0,56
500	100	0,39	525	75	0,39
	150	0,43		125	0,43
	200	0,46		225	0,49
	300	0,53		325	0,56
	400	0,59		425	0,63
	500	0,66		525	0,69
600	100	0,46	625	75	0,46
	150	0,49		125	0,49
	200	0,53		225	0,56
	300	0,59		325	0,63
	400	0,66		425	0,69
	500	0,73		525	0,76
800	100	0,59	825	75	0,59
	150	0,63		125	0,63
	200	0,66		225	0,69
	300	0,73		325	0,76
	400	0,79		425	0,83
	500	0,86		525	0,90
1000	100	0,73	1025	75	0,73
	150	0,76		125	0,76
	200	0,79		225	0,83
	300	0,86		325	0,90
	400	0,93		425	0,96
	500	1,00		525	1,03
1200	100	0,86	1225	75	0,86
	150	0,90		125	0,90
	200	0,93		225	0,96
	300	1,00		325	1,03
	400	1,06		425	1,10
	500	1,13		525	1,16

Tab. 20: Dimensions and weight of the UR-NOVA mounting frames

ODEN Plenum Boxes

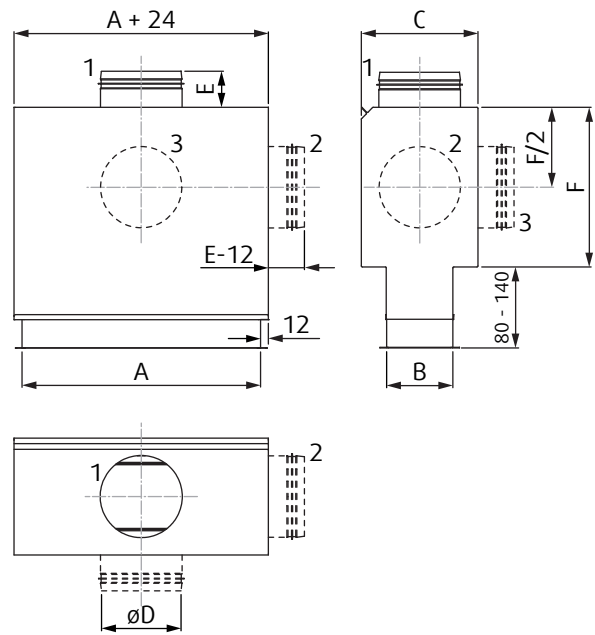
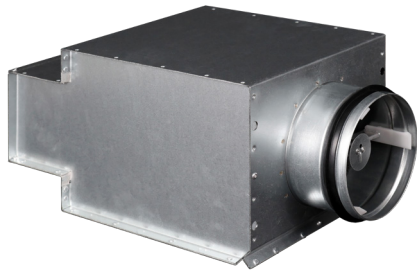

Ordering Code

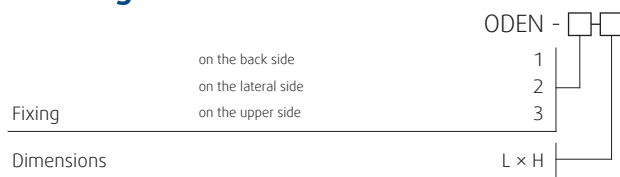

Ordering code example:

ODEN - 1 - 400 x 100

Description

ODEN is a plenum box intended for both air supply and air extract. It can be used along with the NOVA series grilles for the supply air flow velocity reduction and a better distribution (optimizing) of the air flow through the grille. ODEN has an adjustable depth of the grille extension.

The adjustment of the requested air flow is done by a closing perforated damper with plastic tubes for pressure loss measuring (ZEUS damper – please see page 31). It is possible to adjust the damper manually without demounting the grille or the plenum box.

Design

The ODEN plenum box is manufactured from a galvanized steel sheet with a front, lateral or upper side round fixing with a rubber sealing.

Fig. 15: The ODEN plenum box basic dimensions

ODEN	A	B	C	ϕD	E	F
	(mm)					
200 x 100	200	100	175	123	60	250
300 x 100	300	100	210	158	60	290
400 x 100	400	100	210	158	60	290
500 x 100	500	100	250	198	70	320
300 x 150	300	150	250	198	70	320
400 x 150	400	150	300	248	60	370
500 x 150	500	150	300	248	60	370
500 x 200	500	200	370	313	60	430
600 x 200	600	200	370	313	60	430

Tab 21: The ODEN plenum box dimensions

L × H	Connection pos. 1		Connection pos. 2		Connection pos. 3		
	V	øD	V	øD	V	øD	
(mm)							
200 × 100	150	80	200	80	225	100	
300 × 100							
400 × 100							
500 × 100							
600 × 100							
200 × 150		125	250	125	250	250	125
300 × 150							
400 × 150							
500 × 150							
600 × 150		2 × 125					2 × 125
200 × 200		160	285	160	285	285	160
300 × 200							
400 × 200							
500 × 200							
600 × 200		2 × 125					2 × 125
300 × 300		200	325	200	325	325	200
400 × 300							
500 × 300							
600 × 300							
800 × 300		2 × 200					2 × 200
600 × 400	250					250	
800 × 400	2 × 250	375	250	375	375	2 × 250	
1000 × 400							

225 × 75	-	-	-	-	225	100	
325 × 75							
425 × 75							
225 × 125	150	100	225	100	250	125	
325 × 125		78	250	78		123	
425 × 125		100	225	100		125	
525 × 125		160	285	160	285	285	160
325 × 225							
425 × 225							
525 × 225							
625 × 225	200					200	

NOTES: If using the ZEUS damper for fixing 1 the height V must be equal to 225 mm. The ZEUS regulation is only applicable for boxes with width H equal to or higher than 150 mm.

Tab 22: The PB-NOVA plenum box dimensions

The Zeus Damper

The control Zeus damper contains impulse tubes for measuring differential pressure using a portable measuring device. It can be adjusted manually using a cable gearing .

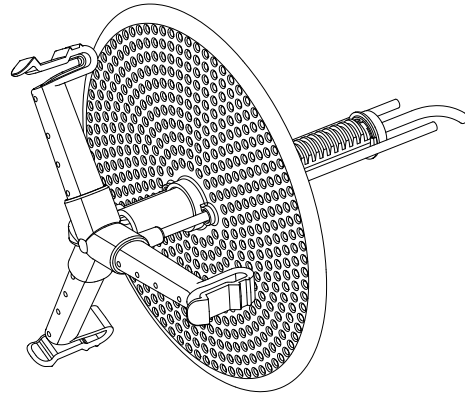

Fig. 17: The Zeus damper

