

KONIKA

Circular Horizontal Discharge Diffuser

Data Sheet



Table of Contents

Description	3
Design	3
Dimensions	4
Ordering Code	4
Quick Selection	4
Accessory	5
Technical Parameters	7
Installation, Maintenance & Operation	13
Transport & Storage	13
Supplement	13
Related Products	14



Description

KONIKA is a circular shaped ceiling diffuser for radial, horizontal air discharge in ceiling height up to 4 m. It is intended for air supply with temperature difference up to ± 10 K from room temperature. It can be eventually used for air extract.

Accessory

Detailed information about accessory for KONIKA is available from page 5.

- THOR: Plenum Box

Design

KONIKA is completed from powder coated sheet steel concentric deflectors at the front side and a spigot without gasket at the rear side for connection to a circular duct or to a plenum box.

Product Parts

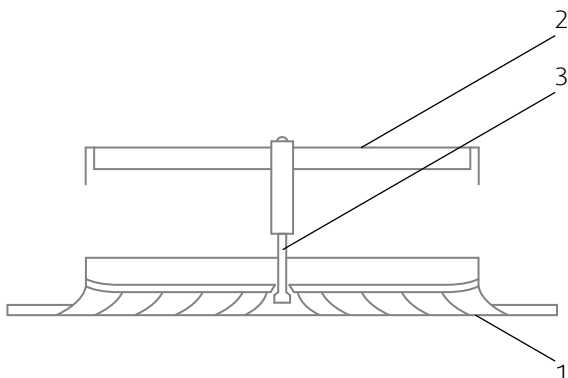

Legend

1	Diffuser KONIKA
2	Mounting bridge (part of delivery)
3	Thread bolt (part of delivery)

Fig. 1: Components of the KONIKA

Dimensions

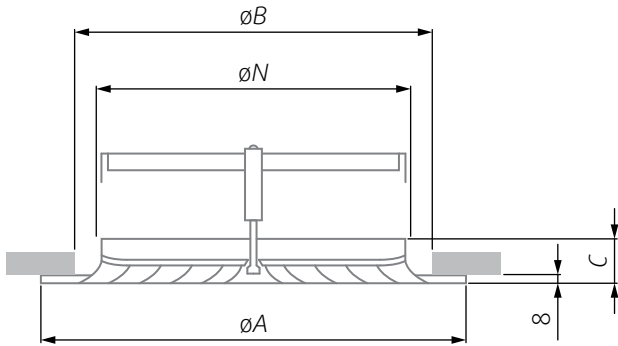

Fig. 2: Dimensions of the KONIKA

Tab. 1: Dimensions of the KONIKA

Type	$\varnothing A$	$\varnothing B$	C	$\varnothing N$
	(mm)			
KONIKA-160	248	190	36	158
KONIKA-220	298	230	36	198
KONIKA-250	363	280	36	248
KONIKA-315	448	350	36	313

Ordering Code

KONIKA- $\varnothing D$

NOTE: Standard surface finish is RAL 9010 white powder coating with 30 % gloss.

Example of the Ordering Code

KONIKA-315

Diffuser with nominal connection size 315 mm, white powder coating RAL 9010, gloss 30 %.

Quick Selection

Type	Air flow volume at different sound power levels L_{WA}					
	25 dB		30 dB		35 dB	
	m^3/h	l/s	m^3/h	l/s	m^3/h	l/s
KONIKA-160	113	31	136	38	161	45
KONIKA-200	192	53	231	64	276	77
KONIKA-250	281	78	326	91	375	104
KONIKA-315	380	106	441	123	508	141

NOTE: The working points were measured with THOR plenum box and open adjustment damper.

Accessory

THOR

Plenum Box



Description

The THOR plenum box is used together with air diffusers for pressure reduction, airflow balancing and sound attenuation as well as for measuring and adjusting the air flow. The plenum box can be used for air inlet and extract.

Design

THOR plenum boxes are manufactured from hot-dip galvanized sheet steel with inlet connection sleeve fitted with a rubber seal tested for air-tightness. The inlet is equipped by the ZEUS damper with impulse tubes for measuring differential pressure for flow volume calculation, using a portable measuring device. It can be adjusted manually using a cable gearing.

Dimensions

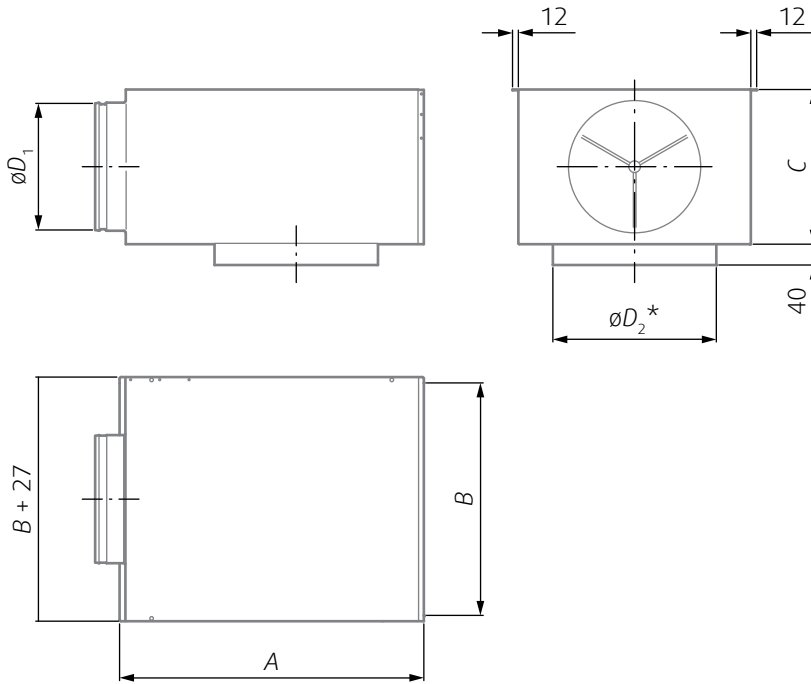

Fig. 3: Dimensions of the THOR

NOTE: * Inner diameter

Tab. 2: Dimensions of the THOR

Type	A	B	C	$\varnothing D_1$	$\varnothing D_2$
	(mm)				
125-160	384	250	160	124	160
160-200	474	300	195	159	200
200-250	524	350	250	199	249
250-315	589	450	300	249	314

Ordering Code



Example of the Ordering Code

THOR-125-160

Plenum box THOR with 125 mm circular inlet and 160 mm circular outlet.

Technical Parameters

Legend

p_s	Pa	Pressure drop
q_v	m ³ /h l/s	Air flow volume
L_{WA}	dB(A)	A-weighted total sound power level
$L_{0,2}$	m	Air throw length with terminal velocity 0,2 m/s
L_x	m	Air throw length calculated for specific terminal velocity
x	m/s	Terminal velocity in range of 0,1 m/s ... 1 m/s

Calculation of Air Throw for Different Terminal Velocities

$$L_x = L_{0,2} \cdot 0,2/x$$

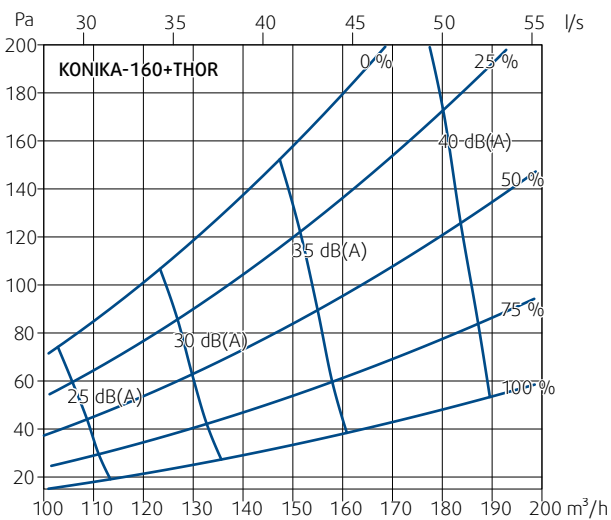

Diagram 1: Pressure drop & A-weighted total sound power level, depending on supply air flow volume, installation with THOR plenum box

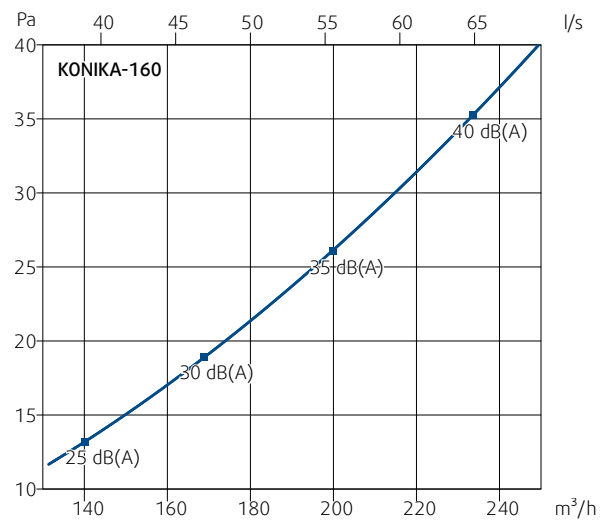

Diagram 3: Pressure drop & A-weighted total sound power level, depending on supply air flow volume, installation without plenum box

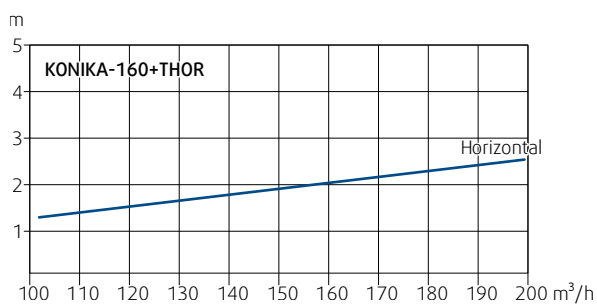

Diagram 2: Isothermal air throw lengths for horizontal radial discharge with terminal velocity 0,2 m/s, depending on air flow volume, installation with THOR plenum box

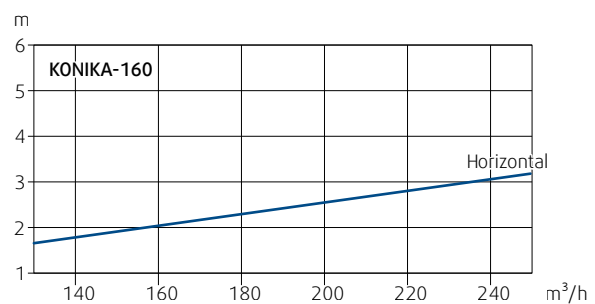

Diagram 4: Isothermal air throw lengths for horizontal radial discharge with terminal velocity 0,2 m/s, depending on air flow volume, installation without plenum box

SUPPLY

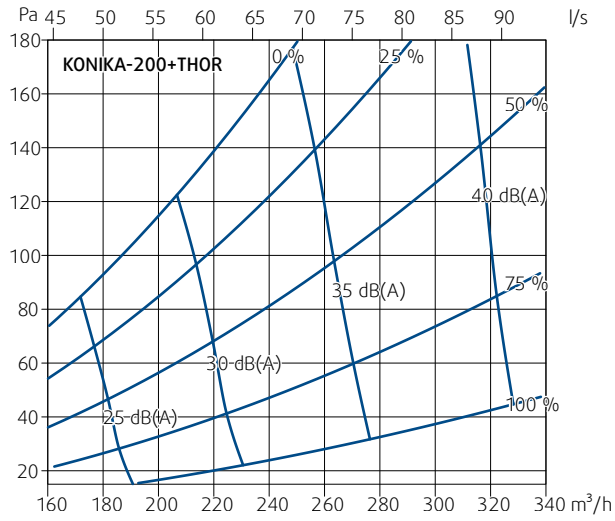

Diagram 5: Pressure drop & A-weighted total sound power level, depending on supply air flow volume, installation with THOR plenum box

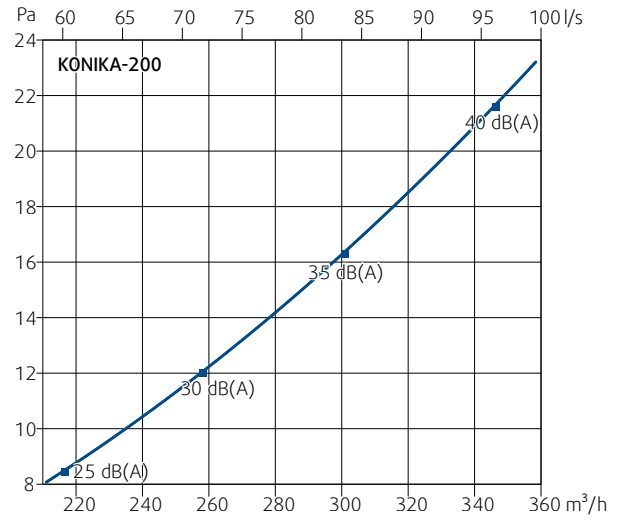

Diagram 7: Pressure drop & A-weighted total sound power level, depending on supply air flow volume, installation without plenum box

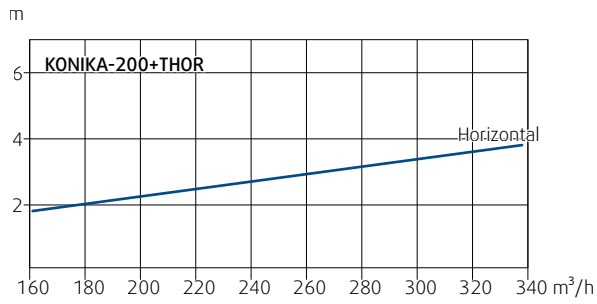

Diagram 6: Isothermal air throw lengths for horizontal radial discharge with terminal velocity 0,2 m/s, depending on air flow volume, installation with THOR plenum box

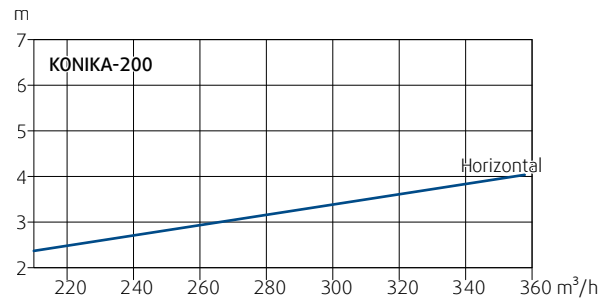

Diagram 8: Isothermal air throw lengths for horizontal radial discharge with terminal velocity 0,2 m/s, depending on air flow volume, installation without plenum box

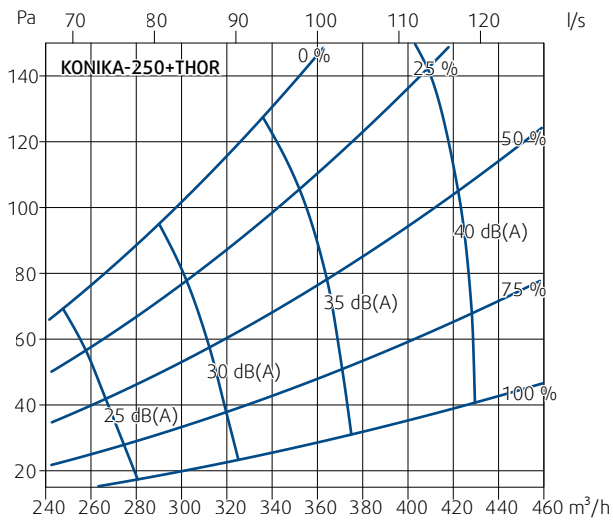

Diagram 9: Pressure drop & A-weighted total sound power level, depending on supply air flow volume, installation with THOR plenum box

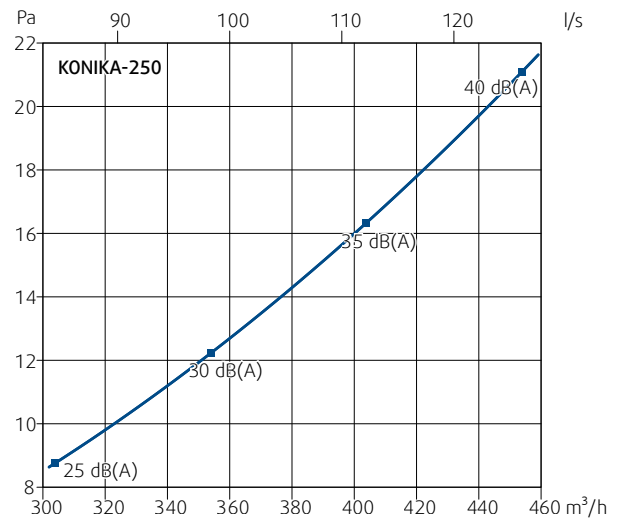

Diagram 11: Pressure drop & A-weighted total sound power level, depending on supply air flow volume, installation without plenum box

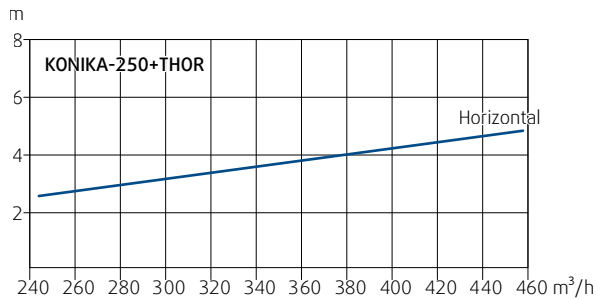

Diagram 10: Isothermal air throw lengths for horizontal radial discharge with terminal velocity 0,2 m/s, depending on air flow volume, installation with THOR plenum box

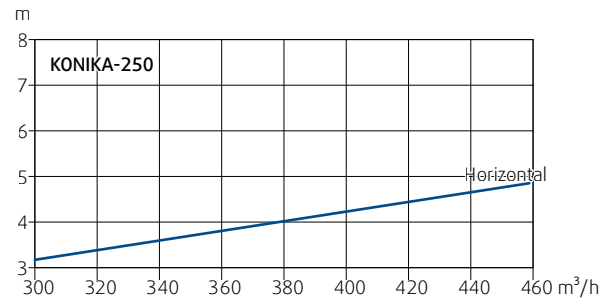

Diagram 12: Isothermal air throw lengths for horizontal radial discharge with terminal velocity 0,2 m/s, depending on air flow volume, installation without plenum box

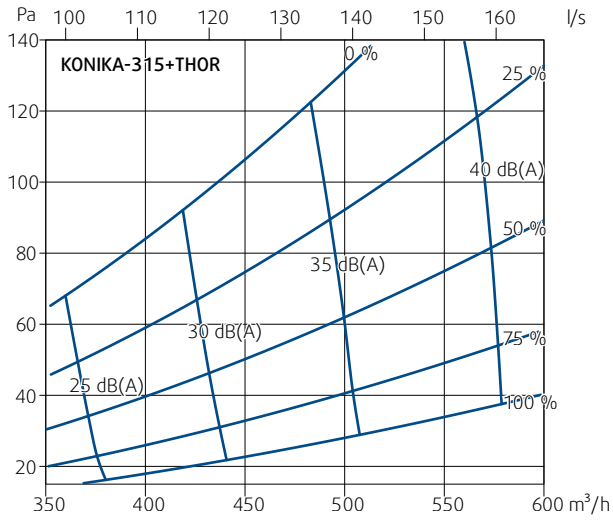

Diagram 13: Pressure drop & A-weighted total sound power level, depending on supply air flow volume, installation with THOR plenum box

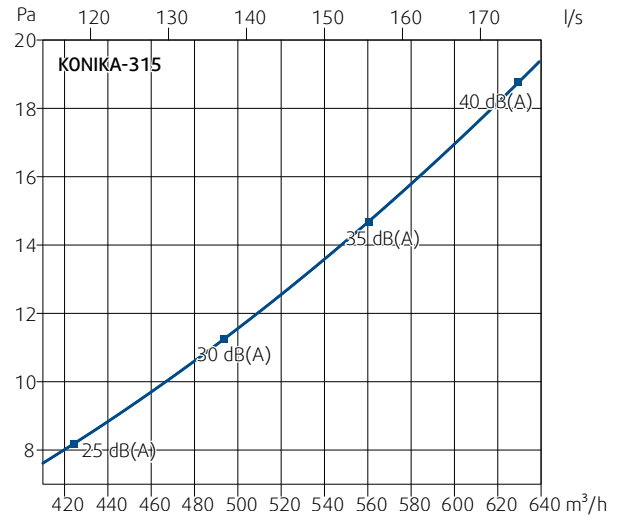
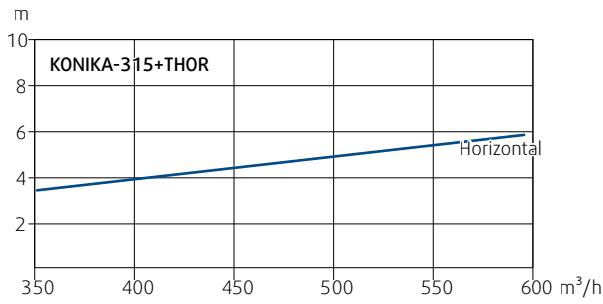

Diagram 14: Pressure drop & A-weighted total sound power level, depending on supply air flow volume, installation without plenum box



Isothermal air throw lengths for horizontal radial discharge with terminal velocity 0,2 m/s, depending on air flow volume, installation with THOR plenum box

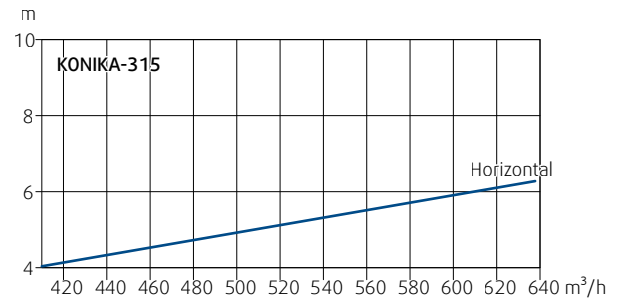

Diagram 15: Isothermal air throw lengths for horizontal radial discharge with terminal velocity 0,2 m/s, depending on air flow volume, installation without plenum box

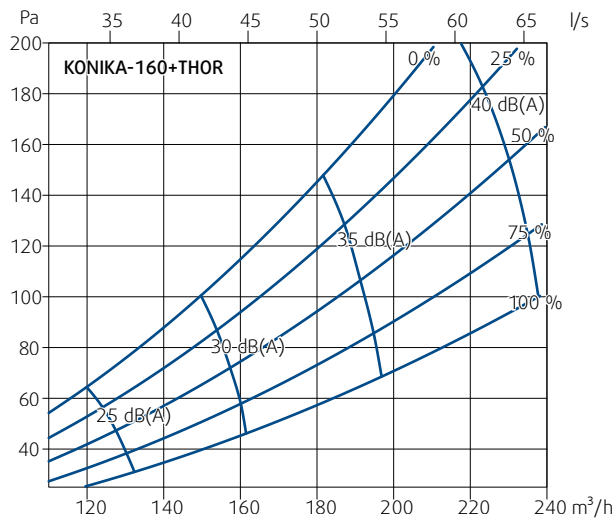

Diagram 16: Pressure drop & A-weighted total sound power level, depending on extract air flow volume, installation with THOR plenum box

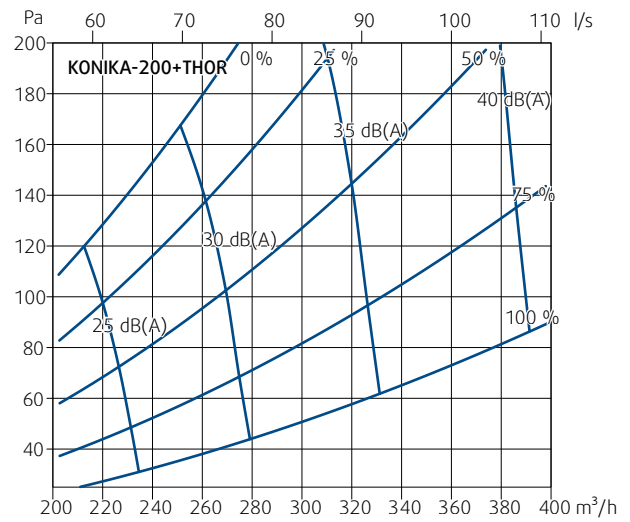

Diagram 18: Pressure drop & A-weighted total sound power level, depending on extract air flow volume, installation with THOR plenum box

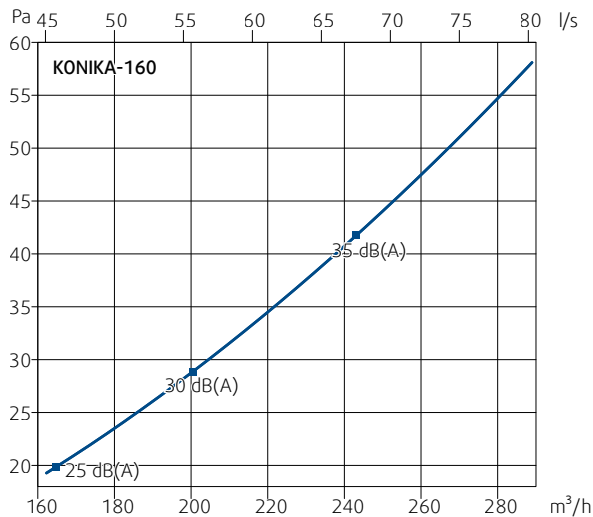

Diagram 17: Pressure drop & A-weighted total sound power level, depending on extract air flow volume, installation without plenum box

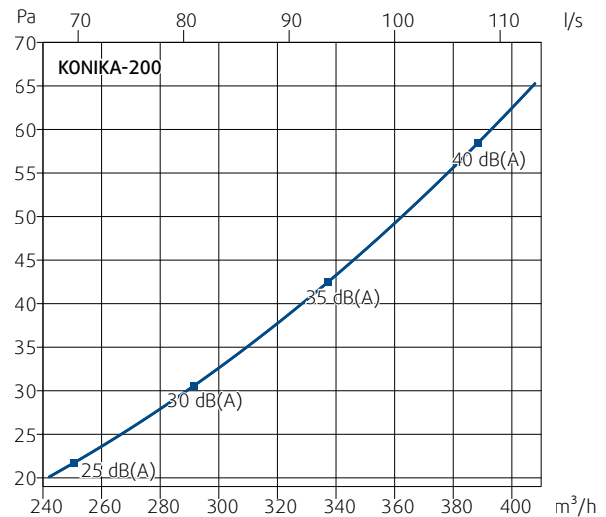

Diagram 19: Pressure drop & A-weighted total sound power level, depending on extract air flow volume, installation without plenum box

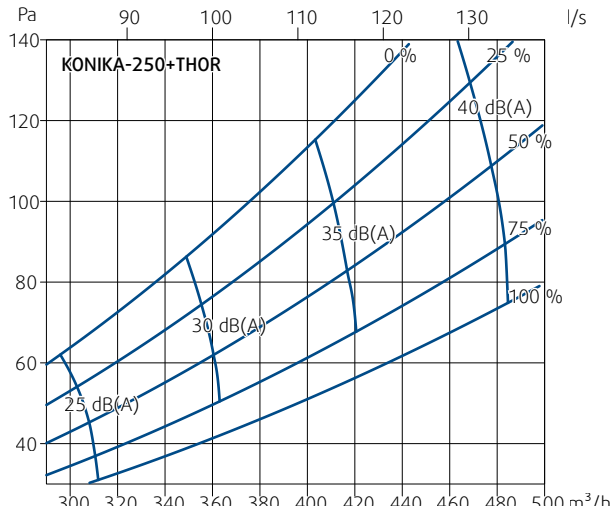

Diagram 20: Pressure drop & A-weighted total sound power level, depending on extract air flow volume, installation with THOR plenum box

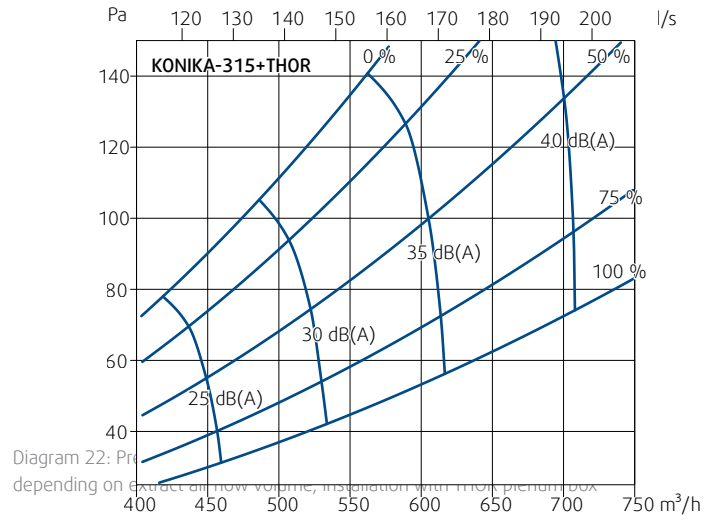

Diagram 22: Pressure drop & A-weighted total sound power level, depending on extract air flow volume, installation with THOR plenum box

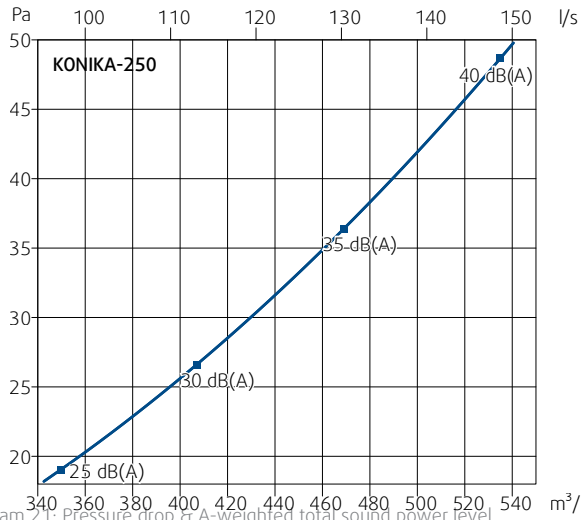

Diagram 21: Pressure drop & A-weighted total sound power level, depending on extract air flow volume, installation without plenum box

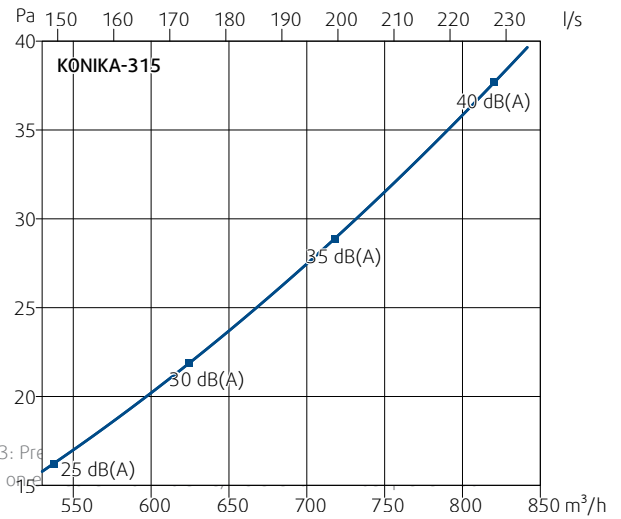

Diagram 23: Pressure drop & A-weighted total sound power level, depending on extract air flow volume, installation without plenum box

Installation, Maintenance & Operation

Information about installation, maintenance and operation is available in the document ["UserManual_KONIKA"](#) or follow the instruction for basic diffusers at [Systemair DESIGN](#).

Transport & Storage

Dry indoor conditions with a temperature range of -20°C to +50°C.

Supplement

Any deviations from the technical specifications contained herein and the terms should be discussed with the manufacturer. We reserve the right to make any changes to the product without prior notice, provided that these changes do not affect the quality of the product and the required parameters.

Current information on all products is available at www.systemair.com

Related Products

ADQ

Ceiling Diffusers with Fixed Deflectors

Product information is available at [Systemair DESIGN](#).

