

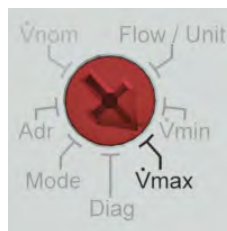

Setting up a VAV has never been easier!

Select Vmax

4



Set air volume

3



Select Vmin

2

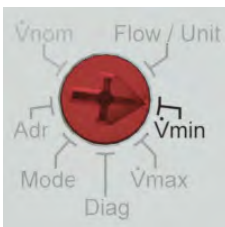

Set air volume

1



GO!

Systemair VAV Optima GO controller

- A – Declutch button.
- B – 3 digit display, test & unit indicator
- C – Value selector ($\Delta 10^\circ$ / Edit)
- D – Function selector



A – Declutch button

Manual declutch button is used if the blade inside the damper needs to be moved manually for example for inspection. However the actuator will control to the desired VAV (or pressure) according to the external reference signal.

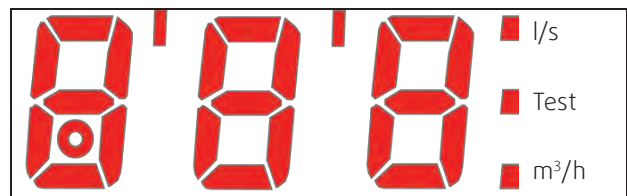

3-digit 7-segment display

B – Display

The display uses 7-segment numbers in full 3-digits. Additional signs include a small circle, three square dots and two rectangular slashes.

The square dots are used with the printed text to visualize units (l/s, m³/h) or if test is ongoing.

An overflow (differential pressure above 250Pa or 1.0inWC) is indicated in the display by a small circle at the first digit.

If the controller tries to match reference and actual flow then this is shown as flashing dot of the chosen unit.

If the controller cannot meet reference and actual flow and therefore hits an end stop the complete display starts flashing to indicate this problem.

If the actuator is turned on and the damper position feedback is activated the display will show REF. The actuator travels from one end-stop to the other in order to learn the maximum angle.

The rectangular slashes are used to define the thousand separators. In this case the display would show numbers as followed:

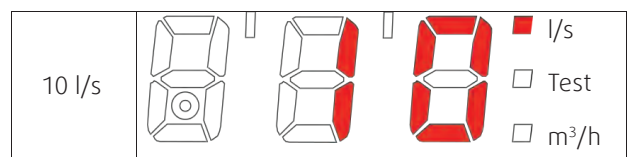
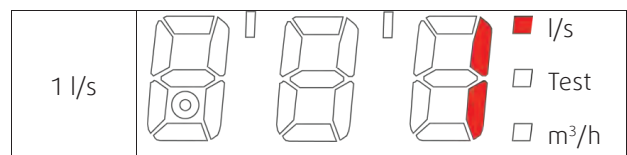

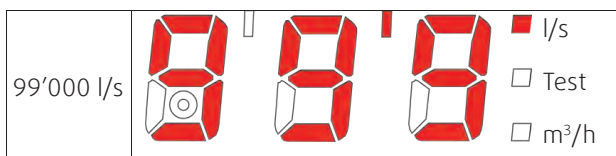
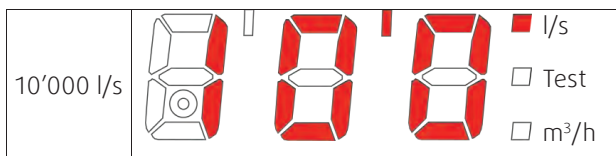
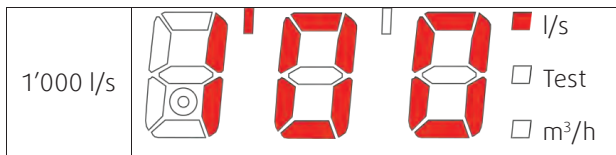
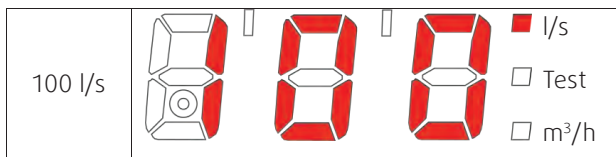

Examples for the display

Display of actual flow (or V_{\min} or V_{\max} according to functional selector)

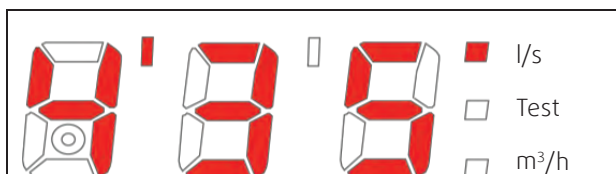

The display shows the flow in 4'350 l/s.

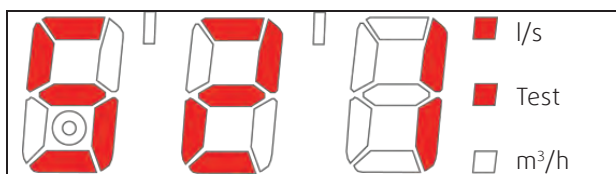

The display shows the flow in 521 l/s and the diagnose mode is turned on.

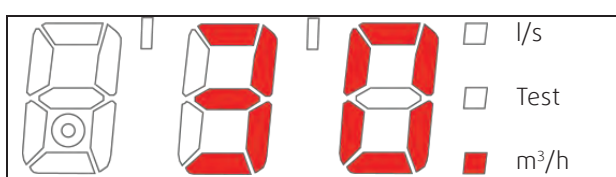

The display shows the flow in 30 m³/h.

C – Value selector ($\Delta 10^\circ$ / Edit)

The value selector allows the changing of values. The position of the arrow shows the value set. The changes are displayed as soon as the selector is moved $\pm 10^\circ$ from its position.

By turning the selector left or right the corresponding values are shown. For change V_{\min} or V_{\max} one can select the appropriate thousand separators.

e.g. if V_{\max} is set to 100 and has to be set to 1'000 one has to turn the selector clockwise toward + until the separator appears in the display. After that it is necessary to adjust to the desired value.

e.g. if V_{\min} is set to 60 and has to be set to 50 one has to turn the selector counter clockwise toward - until a change appears in the display.

After the selection the new value is saved and the display flashes two times for indication. The value is always saved after the selection and the usage of the function selector.

D – Function selector

The function selector allows choosing the function depending on its position. If there is no function selected the display will show three dashes (- - -).

Flow/Unit

Turning the value selector (C) allows unit selection and changes the actual flow to m³/h or l/s. The appropriate dot serves as indicator. The units are automatically converted.

This display matches with the feedback signal U.

The display starts flashing if the servo drive hits an end stop before matching actual to reference flow.

An overflow (higher pressure as 250Pa = 1.0inWC) is indicated in the display by a small circle.

V_{\min}

Allows to set the desired minimum flow for the external reference signal Y=0V or Y=2V directly in m³/h or l/s.

V_{\max}

Allows to set the desired maximum flow for the external reference signal Y=10V directly in m³/h or l/s.

Diag

Opens the diagnostic menu. All outside input signals on Y are neglected and the controller only operates according to the selected override function. All override functions

are disabled after a time-out of 10 hours.

The display toggles after the selection of the function between the actual flow (8s showing time) and the function (2s showing time).

Selecting another function will disable the diagnose function and set it automatically to OFF

oP(en) opens the damper

cl(ose) closes the damper

Hi(gh) forces the actuator to V_{max}

Lo(w) forces the actuator to V_{min}

On Test mode is switched on. The actuator stays in the current position.

oFF Test mode is switched off. The actuator starts controlling according to external signal Y.

123 Showing the software version V123. After 3s showing the display shows oFF again.

Mode

Allows to set the direction of rotation (normal and reverse) and the input signal range (0...10V or 2...10V).

The feedback signal range U corresponds to Y.

0-n ... 0-10V, normal

2-n ... 2-10V, normal

V_{nom}

This setting can be changed only by a Systemair technician.

Setup of VAV actuator

Step by step set-up procedure

1. Connect the actuator to the power supply.
2. Set the function selector (D) and set to Mode, then use the value selector (C) to choose the right analog input signal Y to control the air flow V_{min} can be 0...10V_{DC} or 2...10V_{DC}
3. Set the function selector (D) and set to Flow / Unit, then use the value selector (C) to choose the right unit. The l/s is pre-selected. The values set are converted between the different units. The display also shows the current flow detected by the controller.
4. Set the function selector (D) and set to V_{max} , then use the value selector (C) to choose the desired maximum flow.
The values that can be selected in the range from 0 to V_{nom} in 255 steps.
So in the given example from:
0...251 l/s with increments of 0.98 l/s
The controller always takes the next smallest integer for the display. It is not possible to set any value

smaller than the increments.

If one needs $V_{max} = 175$ l/s the value 175 has to be set. [175]

5. Set the function selector (D) and set to V_{min} , then use the value selector (C) to choose the desired minimum flow

The values that can be selected range from 0 to V_{nom} in 255 steps. The setting is similar to V_{max} and the controller always takes the next smallest integer for the display. It is not possible to set any value smaller than the increments.

If one needs $V_{min} = 50$ l/s the value 50 has to be set [50]

Step by step Test procedure

1. Set the function selector (D) and set to Flow/Unit. The display shows the actual flow.
If the display flashes this number it means that the controller is unable to reach the de-sired air flow. This can result in either too much air (turbulences) or too little air.

e.g. the display flashes 50 l/s
2. Set the function selector (D) and set to Diag. One should read in the display oFF and the actuator is controlling according to external signal Y. This signal Y shall be shown in the range of 0...10 V. This is to see the external reference signal.
Using value selector (C) it is possible to set the following diagnostic functions:
cl this closes the damper and keeps it close.
oP this opens the damper and keeps it open.
Hi this forces the controller to V_{max} .
Lo this forces the controller to V_{min} .
On this turns the test function on.
oFF this turns the test function off.

If any diagnostic cl, oP or on, Hi, Lo function is selected, the display shows the Test dot.

e.g. set diagnostic function to Lo

3. The display starts toggling between actual flow and the selected function.
4. Set the function selector (D) to Flow / Unit. This turns off the diagnostic function automatically. If the diagnostic function is not turned off the controller resets this setting after 16 hours.

Setting the controller to a constant air flow

The controller can be set to a constant air flow neglecting all analog inputs Y. This functionality can be used as an advanced diagnostic function. To activate this function one needs to set Vmax to 0. In this case the Test dot in the display starts flashing and the controller uses V_{min} as the constant air flow to control to.

The input signal Y allows to control the VAV actuator according to the selected mode of operation.

Schematic diagram for external override commands

Specialty of input mode 2...10V_{DC}:

In the range of $Y = 0 \dots 0.8$ V the override command Close will be detected. The upper value of 0.8V is subject to change by Systemair. Several fixed settings are available for choice (0.8 V / 1.0 V / 1.2 V / 1.4 V / 1.6 V / 1.8 V). In the range of $Y = 0.8 \dots 2$ V the controller detects V_{min} .

Specialties of both input modes (0)2...10 V_{DC}:

In both modes it is possible to define a Zero value of air-flow. This allows the controller the programming of an air-flow value which is used as zero. If e.g. the zero value is set to $V_{Null} = 1,2\%$ of V_{nom} the controller will read all air flows smaller as V_{Null} as zero flow. If the value $V_{min} = 0$ is set the zero value allows the setting of a threshold for closing the damper.

Forced operations

Standard operation, V_{min} corresponds to 0V (2V) and V_{max} to 10V. if 0,5V is reached the damper will close

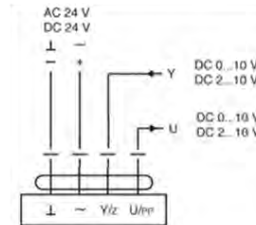

Forced operation, CAV mode; V_{min} is the constant value

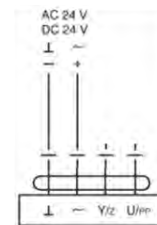

Forced operation, 0(2)-10V control signal, switch will close the damper

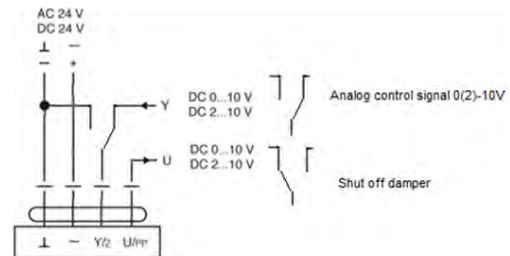

Forced operation, V_{min} & V_{max} . V_{min} during normal operation, V_{max} is forced via a switch

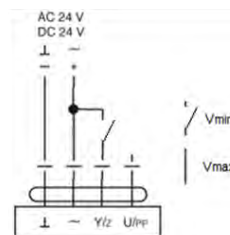

Forced operation, switch closes the damper

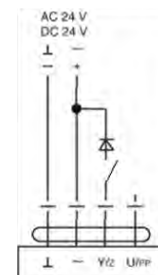

Forced operation, switch opens the damper

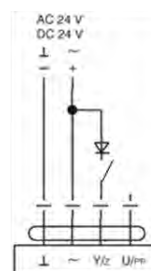

Forced operations in overview (The contacts are mutually interlocking):

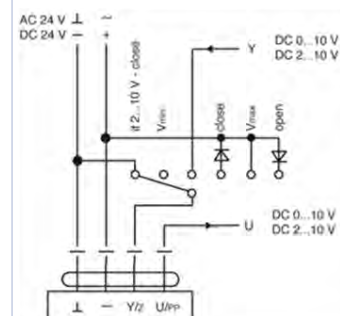

Connection scheme

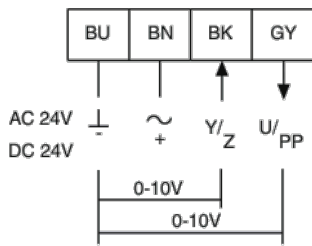

BU = blau, blue
 BN = braun, brown
 BK = schwarz, black
 GY = grau, grey

BU-BN	Betriebsspannung	24 VAC / DC
BU-BK	Regelspannung	0...10 V / 2...10 V
BU-GY	Rückführsignal	0...10 V / 2...10 V
Last für Ausgang GY:		max. 0,5 mA
BU-BN	operating voltage	24 VAC / DC
BU-BK	control signal	0...10 V / 2...10 V
BU-GY	feedback signal	0...10 V / 2...10 V
load for output GY:		max. 0.5 mA

Actuators are provided with color coded wires. Associated to the color you find numbers as follows BU = 1, BN = 2, BK = 3 and GY = 4.

Running time	100 s / 90° (5 Nm)
Connection	24 VAC/DC
Control	0 / 2...10V proportional [V_{min} ... V_{max}]
Feedback	0 / 2...10V proportional
Temperature operation	0...+50°C
Temperature storage	-20...+80°C
Humidity	5...95% r.H. non condensing

Approvals / Standards

CE (2004/108/EG, 2006/95/EG)
 EN 60730-1 and EN 60730-2-14